



Department of
**Agriculture,
Food and the Marine**

An Roinn
**Talmhaíochta,
Bia agus Mara**

T11/86

AQUACULTURE LICENCE

AQUACULTURE MARINE SHELLFISH
INTER/SUB-TIDAL
(Structures e.g. trestles)

Eamonn Caffrey
9 Priory Chase
St. Rapael's Manor
Celbridge
Co. Kildare

TABLE OF CONTENTS

1. **LICENSED AREA**
 2. **SPECIES, CULTIVATION AND METHOD LICENSED**
 3. **INFRASTRUCTURE AND SITE MANAGEMENT**
 - Indemnity*
 - Design, Arrangement and Maintenance of Structures*
 - Operational Conduct*
 - Waste Management*
 - Inspection*
 4. **NAVIGATION AND SAFETY**
 5. **MONITORING**
 6. **FISH HEALTH / MORTALITY MANAGEMENT / MOVEMENT OF FISH**
 - Fish Health Regulations*
 - Disposal of Mortalities*
 - Movement of Fish*
 7. **DURATION, CESSATION, REVIEW, REVOCATION, AMENDMENT, ASSIGNMENT**
 - Duration, Cessation*
 - Review*
 - Revocation, Amendment*
 - Assignment*
 8. **FEES**
 9. **GENERAL TERMS AND CONDITIONS**
 - Notification*
 - Tax Clearance Certificate*
 - Companies and Co-operatives*
 - Clearance of Site*
- SCHEDULE 1*
SCHEDULE 2
SCHEDULE 3
SCHEDULE 4

AQUACULTURE LICENCE NO. 1119

GRANTED UNDER THE FISHERIES (AMENDMENT) ACT, 1997 (NO. 23 of 1997)

The Minister for Agriculture, Food and the Marine (hereinafter referred to as the “Minister”), in exercise of the powers conferred on him by the Fisheries (Amendment) Act, 1997 (No. 23 of 1997) (hereinafter referred to as the “Act”), grants an Aquaculture Licence to:

Eamonn Caffrey
9 Priory Chase
St. Raphael’s Manor
Celbridge
Co. Kildare

(hereinafter referred to as the “Licensee”) for the cultivation of Pacific Oysters on a site in Dorrin’s Strand area of Sligo Bay, Co Sligo as specified in Schedule 1 attached (numbered T11/86A) and indicated by a red line on the attached map in accordance with the plans and drawing(s) in Schedule 2 attached as approved of by the Minister, subject to the Act and Regulations made under the Act and to the terms and conditions set out in the attached pages.

This Aquaculture Licence shall remain in force for a maximum period of ten (10) years commencing on 11th April 2018, provided for so long as the Foreshore Licence granted on 11th April 2018, under Section 3(1) of the Foreshore Act 1933 (No.12 of 1933) in respect of the same site for the purpose referred to is in force.



A person authorised under Section 15(1)
of the Ministers and Secretaries Act 1924 to
authenticate the Seal of the Minister for
Agriculture, Food and the Marine.

TERMS AND CONDITIONS APPLYING TO THIS AQUACULTURE LICENCE

1. Licensed Area

- 1.1 The area specified in *Schedule 1* attached (3.626 hectares) (labelled T11/86A) and outlined in red on the map(s) in *Schedule 1*.
- 1.2 The co-ordinates for the site are based on the Irish National Grid Co-ordinate System.

2. Species, Cultivation and Method Licensed

- 2.1. Species to be farmed: Pacific Oysters.
- 2.2. Method: Bags and Trestles subject to the stocking and/or deployment limits as may be specified in *Schedule 4* attached.
- 2.3. The introduction of seed to the site shall comply with the legislation relating to fish health.

3. Infrastructure and Site Management

Indemnity

- 3.1. The Licensee shall indemnify and keep indemnified the State, the Minister, his officers, servants or agents against all actions, loss, damage, costs, expenses and any demands or claims howsoever arising in connection with the construction, maintenance or use of any structures, apparatus, equipment or any other thing used in connection with the licensed operation in the licensed area or in the exercise of the rights granted under the licence and the Licensee shall take such steps as the Minister may specify in order to ensure compliance with this condition.
- 3.2. The duty of maintenance and responsibility for the upkeep and safety of the site rests with the Licensee.

Design, Arrangement and Maintenance of Structures

- 3.3. The Licensee shall ensure that the equipment (including all flotation, mooring and anchoring devices) is placed within the licensed area only. Storage or placement of equipment or stock on the foreshore or seashore outside the licensed area is not permitted under any circumstances.
- 3.4. The Minister may direct as to the deployment of apparatus and flotation devices and their colour, within the site.
- 3.5. The Licensee shall obtain the prior approval of the Minister to any proposed material change to the plan/drawings or equipment as approved being used during the licensing period as specified in *Schedule 2* attached.

- 3.6. The Licensee shall at all times for the duration of the licence keep all equipment used for the purposes of the licensed operations in a good and proper state of repair and condition to the satisfaction of the Minister or other competent State authority.
- 3.7. The Licensee shall ensure that each trestle grouping/pole and all flotation and mooring devices in the licensed area legibly bear the Aquaculture Licence Number in an indelible weatherproof format.

Operational Conduct

- 3.8. The Licensee shall conduct its operations in a safe manner and with regard for other persons in the area and the environment and shall ensure that the operations are not injurious to adjacent lands or the public interest (including the environment) and do not interfere with navigation or other lawful activity in the vicinity of the licensed area, and shall comply with any lawful directions issued by the Minister and any other competent State authority in that regard.
- 3.9. The Licensee shall ensure that any aquaculture or other activity conducted under this licence does not adversely affect the integrity of the Natura 2000 network (if applicable) through the deterioration of natural habitats and the habitats of species and/or through disturbance of the species for which the area has been designated in so far as such a disturbance may be significant in relation to the stated conservation objectives of the site concerned.
- 3.10. The Licensee shall ensure that tractors (or other vehicles) accessing and leaving the site adhere strictly to approved access and egress routes as specified in Schedule 1 attached. Full compliance is required in order to minimise disturbance to the foreshore and habitat. All drivers shall be made fully aware of the specific route approved.
- 3.11. The Licensee shall ensure that journeys back and forth on the approved access and egress routes are kept to the minimum necessary.
- 3.12. The Licensee shall ensure that all tractors/towing vehicles to be used for aquaculture purposes on the foreshore are fitted with efficient exhaust/silencers/mufflers and that vibration noise from tractors and machinery is kept to a minimum.
- 3.13. The Licensee shall ensure that all vehicles are properly maintained so as to prevent leakages of oils, fuels, grease etc.
- 3.14. The Licensee shall ensure that all vehicles move slowly at all times on the foreshore, that engine revolution is kept to a minimum and that engines are turned off when not in use.
- 3.15. The Licensee shall ensure that if more than one vehicle is needed on the shore that all vehicles, where possible, arrive and depart together.
- 3.16. The Licensee shall so organise its operations in consultation with other licensed operators to ensure that the total number of vehicles and harvesting machines on the foreshore on any one day is kept to the minimum necessary.

- 3.17. The Licensee shall ensure that when carrying out aquaculture work on the foreshore, dogs owned or under the control of the Licensee shall not be present, in order to minimise disturbance to the birdlife in the area.
- 3.18. The Licensee shall ensure that best practice is employed to keep structures and netting clean at all times and any biofouling by alien invasive species shall be removed and disposed of in a responsible manner. In particular, in 'Natura 2000' sites care must be taken to ensure that any biofouling by alien invasive species will not pose a risk to the conservation features of the site. Measures to be undertaken are set out in the draft Marine Code of Practice prepared by Invasive Species Ireland and can be found on the web site at: <http://invasivespeciesireland.com/>.

Waste Management

- 3.19. The Licensee shall ensure that the licensed and adjoining area shall be kept clear of all redundant structures (including apparatus, equipment and/or uncontained stock), waste products and operational litter or debris and shall make provision for the prompt removal and proper disposal of such material. If the Licensee refuses or fails to do so, the Minister may cause the said structures, apparatus, equipment or other thing to be removed and the licensed area restored and shall be entitled to recover from the Licensee as a simple contract debt in any court of competent jurisdiction all costs and expenses incurred by him in connection with the removal and restoration.

Inspection

- 3.20. The licensed area and any equipment, structure, thing, or premises wherever situated used in connection with operations carried out in the licensed area shall be open for inspection at any time by an authorised person (within the meaning of Section 292 of the Fisheries (Consolidation) Act 1959) (No. 14 of 1959) (as amended by Fisheries Act 1980) (No. 1 of 1980), a Sea Fisheries Protection Officer (within the meaning of Sea Fisheries and Maritime Jurisdiction Act 2006) (No. 8 of 2006) or any other person appointed in that regard by the Minister or other competent State authority.
- 3.21. The Licensee shall give all reasonable assistance to an authorised officer or a Sea Fisheries Protection Officer or any person duly appointed by any competent State authority to enable the person or officer enter, inspect, examine, measure and test the licensed area and any equipment, structure, thing or premises used in connection with the operations carried out in the licensed area and to take whatever samples may be deemed appropriate by that person or officer.
- 3.22. The Licensee shall keep and maintain in the State for inspection on demand by the Minister or a competent State authority, at all times, records of all operations including compliance monitoring and any required follow up action. These records shall be produced by the Licensee on demand by the Minister or other competent State authority and in any event not later than 24 hours from the making of that demand.
- 3.23. The Licensee shall furnish to the Minister or other competent State authority in the form and at the intervals determined by the Minister or other competent State

authority, such information relating to the licensed area as may be required to determine compliance by the Licensee with the terms of this licence and applicable legislation.

4. **Navigation and Safety**

- 4.1. The Licensee shall ensure that Statutory Sanction from the Commissioners of Irish Lights is in place prior to the commencement of operations, regarding all aids to navigation. Statutory Sanction forms are available at <http://www.cil.ie/safety-navigation/statutory-sanction.aspx>.
- 4.2. The Licensee shall ensure that the site is marked in accordance with the requirements of both the Marine Survey Office and the Commissioners of Irish Lights as specified in *Schedule 3*.
The navigation marking detail is as illustrated in *Schedule 3*.
- 4.3. The Licensee shall comply with any specification requirement relating to navigational aids, flotation and mooring devices, supporting/marketing posts/poles, as required by the Minister or any other competent State authority.
- 4.4. Prior to commencement of operation the Licensee shall inform the UK Hydrographic Office at Taunton, of the location and nature of the site in order that charts and nautical publications can be updated. Tel: 00 44 1823337900 Fax: 00 44 1823 284077 Email: sdr@ukho.gov.uk the Licensee shall submit proof to the Department within 14 days of the date of this licence that the UK Hydrographic Office has been so informed.

5. **Monitoring**

- 5.1. The Licensee shall undertake and/or partake in monitoring, in particular environmental monitoring, as directed by the Minister or other competent State authority.

6. **Fish Health / Mortality Management / Movement of Fish**

Fish Health Regulations

- 6.1. Before the site is stocked the Licensee shall ensure that a Fish Health Authorisation under statutory provisions giving effect to Council Directive No. 2006/88/EC, as amended, or any other legislative act that replaces that Directive on animal health requirements for aquaculture animals and their products, and on the prevention and control of certain diseases in aquatic animals, is in place.

Disposal of Mortalities

- 6.2. The Licensee shall dispose of dead fish in accordance with the applicable statutory provisions and requirements.

Movement of Fish

- 6.3. The Licensee shall comply with any regulations in force governing the movement of fish.

7. **Duration, Cessation, Review, Revocation, Amendment, Assignment**

Duration, Cessation

7.1. This Licence shall remain in force until 10th April 2028, and as long as the accompanying Foreshore Licence remains in force.

Review

7.2. The Licensee may apply for a review of the licence at any time after the expiration of three years since the granting of the licence or its last renewal in accordance with section 70 of the Act.

Revocation, Amendment

7.3. Subject to the Act, the Minister may revoke or amend the licence if:–

- (a) he considers that it is in the public interest to do so,
- (b) he is satisfied that there has been a breach of any condition specified in the licence e.g., operating outside the licensed area,
- (c) the licensed area to which the licence relates is not being properly maintained,
- (d) water quality results or general performance in the licensed area do not meet the standards set by the Minister or the competent State authority.

Assignment

7.4. This Licence shall not be assigned without the prior written consent of the Minister and may not be assigned during the period of three years, dating from the commencement or renewal of this licence, unless the Minister determines that it may be assigned under condition 7(5) or the condition set out in 7(6) applies.

7.5. A Licensee, who considers that there are exceptional reasons for the assignment of the Licence during the first three years, may apply to the Minister, giving those reasons, for a determination that the Licence may be assigned. The Minister may, at his discretion, having considered the reasons given by the Licensee, determine whether or not the Licence may be assigned. The determination of the Minister in this regard is final.

7.6. Where the Licensee is a company (within the meaning of the Companies Acts) and goes into Liquidation (within the meaning of the Companies Acts) in the first three years dating from the commencement of the licence, the Liquidator shall, with the consent of the Minister, be entitled to assign the licence to enable him to discharge any debts of the liquidated company.

7.7. This licence is issued subject to any order that the High Court may make under section 218 of the Companies Act 1963 or otherwise with regard to the assignment of this licence.

8. **Fees**

- 8.1. The Licensee shall pay to the Minister an annual aquaculture licence fee in accordance with the Aquaculture (Licence Application and Licence Fees) Regulations 1998(S.I. No. 270/1998) as amended by the Aquaculture (Licence Fees) Regulations 2000 (S.I. No. 282 of 2000) or an amount payable under Regulations made under section 64 of the Act.
- 8.2. The Minister may revoke the licence where the Licensee fails to pay the aquaculture licence fees on demand.

9. **General Terms and Conditions**

- 9.1. The Licensee shall at all times comply with all laws applicable to aquaculture operations.
- 9.2. Any reference to a statute or an act of an institution of the European Union (whether specifically named or not) includes any amendments or re-enactments in force and all statutory instruments, orders, notices, regulations, directions, bye-laws, certificates, permissions and plans made, issued or given effect under such legislation shall remain valid.
- 9.3. If any condition or part of a condition in this licence is held to be illegal or unenforceable in whole or in part, such condition shall be deemed not to form part of this licence but the enforceability of the remainder of this licence is not affected.
- 9.4. The Licensee shall at all times hold all necessary licences, consents, permissions, permits or authorisations associated with any activities of the Licensee in connection with the licensed area.

Notification

- 9.5. Without prejudice to any other remedy under the licence or in law, if the Minister is of the view that the Licensee is in breach of any obligation under this licence, the Minister may, by notice in writing, require that the Licensee rectifies such breach, within such time as is specified by the Minister. The Licensee shall comply with any direction of the Minister within the time specified in the notice.
- 9.6. Any notice to be given by the Minister may be transmitted through the Post Office addressed to the Licensee at the last known address of the Licensee.
- 9.7. The Licensee shall notify the Minister within 7 days of any change in the Licensee's address, telephone, e-mail or facsimile number.

Tax Clearance Certificate

- 9.8. During the term of this licence the Licensee shall provide to the Minister on demand a current tax clearance certificate.

Companies and Co-operatives

- 9.9. In the event of the licence being granted to a company (within the meaning of the Companies Acts), control of the licensee company shall not change in any respect from the control of the company as existed on the date that the licence was granted so long as this licence shall remain in force save with the prior written permission of the Minister.
- 9.10. In the event of a licence being granted to a company that has been incorporated outside this State, the licensee company shall register with the Companies Registration Office within one month of the establishment of a place of business in the State or alternatively, within one month of the establishment of a branch of the said company in the State and the licensee company shall submit proof to the Department within 14 days of the end of that month that it has been so registered.
- 9.11. Where the licensee is a company within the meaning of the Companies Acts, the licensee company shall ensure that it does not become dissolved within the meaning of the Companies Acts for so long as this licence shall remain in force.
- 9.12. In the event of the licence being granted to a society (within the meaning of section 2 of the Industrial and Provident Societies (Amendment) Act 1978 (No.23 of 1978) the following conditions shall apply:-
- 9.12.1. The rules relating to membership of the society shall enable any resident of the State to become a member of it where the resident fulfils all the conditions laid down by the society for membership of it and the rules shall not lay down different conditions for different classes of people;
- 9.12.2. The rules relating to the society as submitted to the Minister before the grant of this licence shall not be amended subsequently other than with the written permission of the Minister; and
- 9.12.3. The Minister may, if he considers it necessary in the interests of good management of the licensed area, direct that an amendment may be made to the rules of the society, and the Licensee shall amend the rules in accordance with that direction.

Clearance of Site

- 9.13. The Licensee shall, at the Licensee's own expense, if so required by written notice from the Minister and within three weeks after receipt of such notice or on cessation of the licence for any other cause, remove the structures, apparatus, equipment or any other thing to the satisfaction of the Minister. If the Licensee refuses or fails to do so, the Minister may cause the said structures, apparatus, equipment or other thing to be removed and the licensed area restored and shall be entitled to recover from the Licensee as a simple contract debt in any court of competent jurisdiction all costs and expenses incurred by him in connection with the removal and restoration. The Licensee shall take such steps as the Minister may specify in order to secure compliance with this condition.

SCHEDULE 1

Schedule 1 contains:

- **the co-ordinates of the site based on the Irish National Grid Co-ordinate System and the area of the site**
- **a chart showing the location of the site in relation to the surrounding area**
- **site map(s) which also shows the access/egress route to and from the site**
Follow the Coney Island public access causeway northwestwards until it intersects another access route halfway between

1 NO. SITE AT SLIGO HARBOUR CO.SLIGO

Co-ordinates & Area

Site T11/086A (3.626 Ha)

The area seaward of the high water mark and enclosed by a line drawn from Irish National Grid Reference point

162435, 336949 to Irish National Grid Reference point

162718, 336833 to Irish National Grid Reference point

162744, 336713 to Irish National Grid Reference point

162395, 336845 to the first mentioned point.

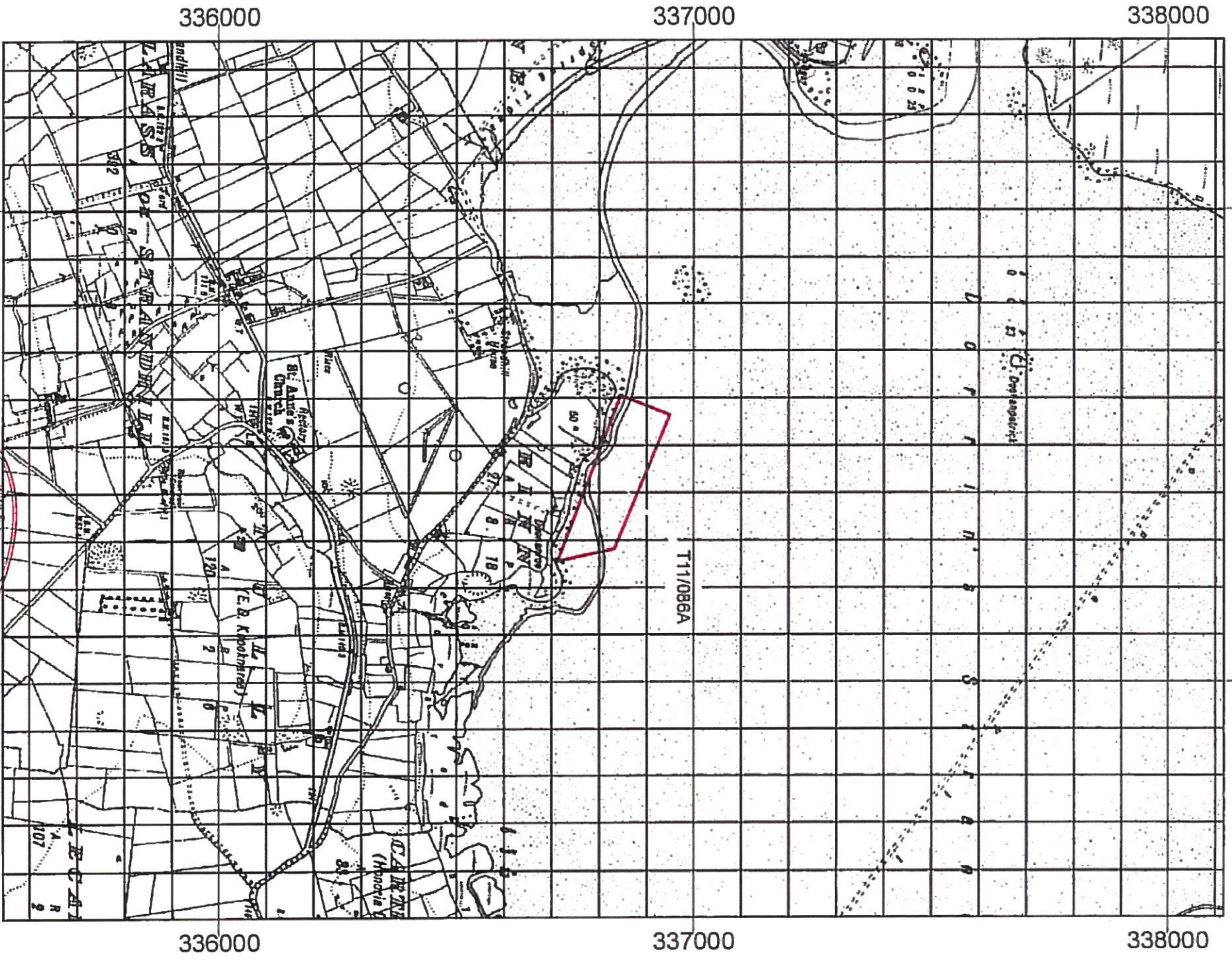

162000

163000

338000

337000

336000

162000

163000

T11/086A

Aqua Culture Sites
<all other values>

- Application
- Uplisted
- Revised
- Surrounded
- Withdrawn
- 100 Meter Reference Grid

1:10,560



Sites highlighted in red denotes Applications
 Ordinance Survey Ireland Licence No. EN0956475
 © Ordnance Survey Ireland/Government of Ireland



Department of
**Agriculture,
 Food and the Marine**
 An Roinn
 Talmhaíochta,
 Bia agus Mara

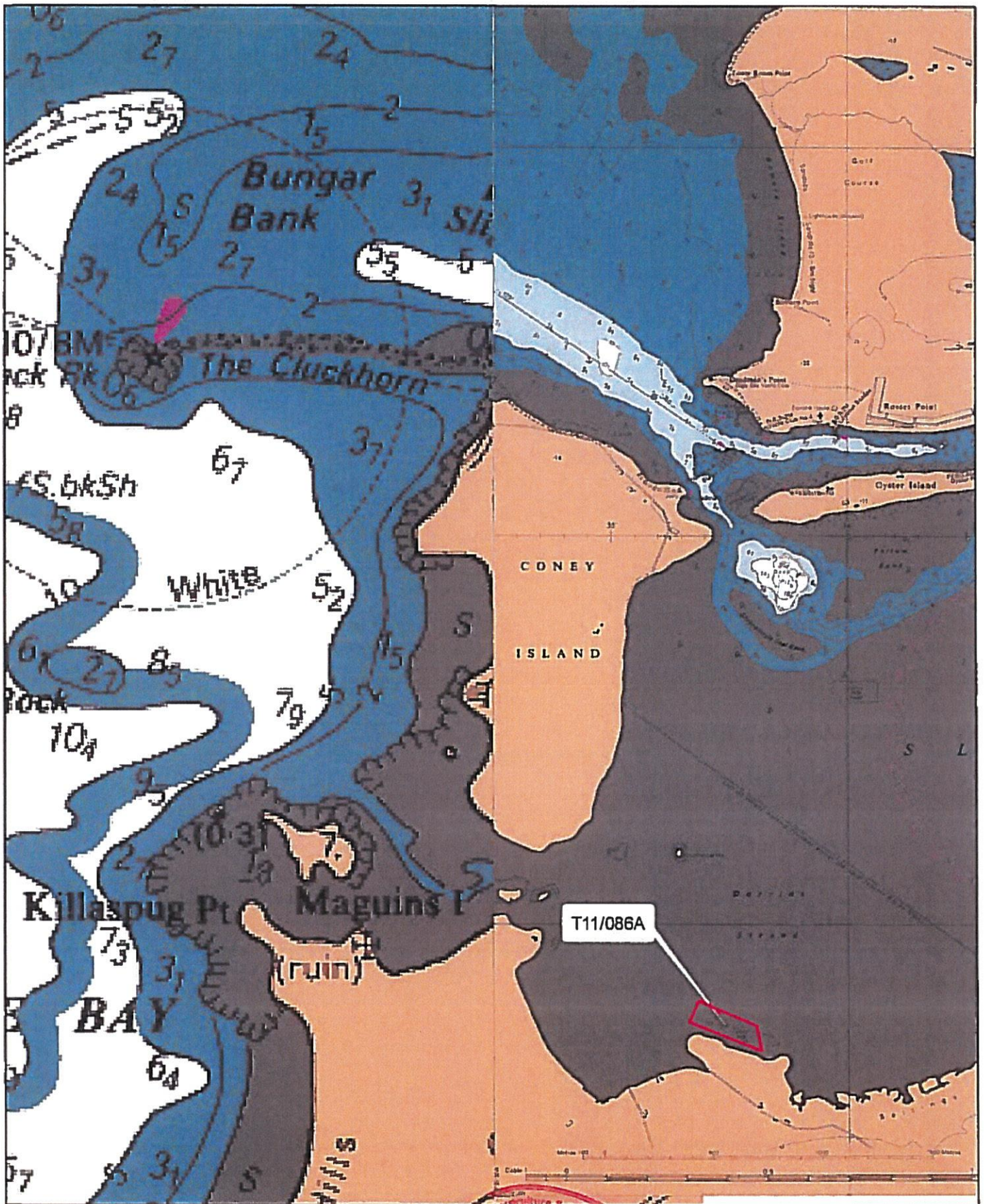

Aqua Cultura Sites

<all other values>

Site_Status

- Application
- Lapsed
- Licensed
- Refused
- Revoked
- Surrendered
- Withdrawn
- 100 Meter Reference Grid

1:24,000

Sites highlighted in red denotes Application
 Part of Admiralty Chart No =2767-1,2852-1
 Not to be used for Navigation



Department of
**Agriculture,
 Food and the Marine**
 An Roinn
**Talmhaíochta,
 Bia agus Mara**



SCHEDULE 2

Schedule 2 contains:

- **the approved plans and drawing(s)**

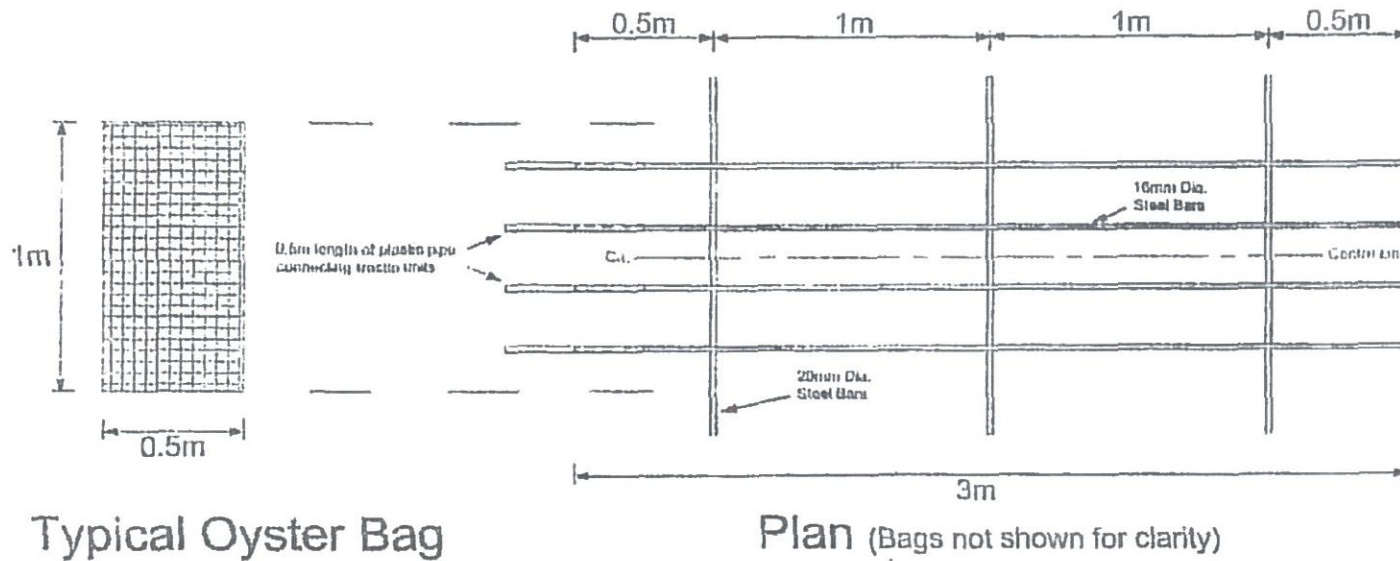
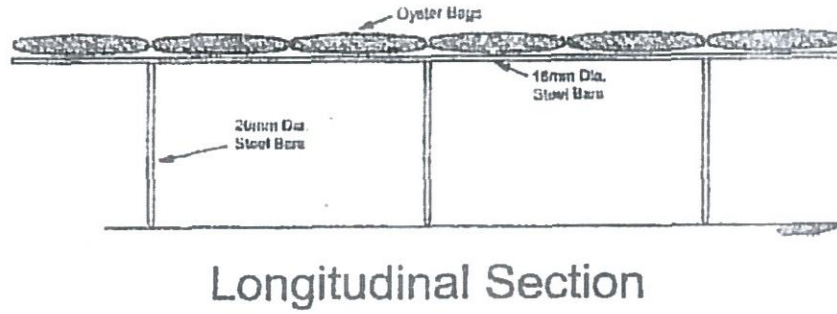
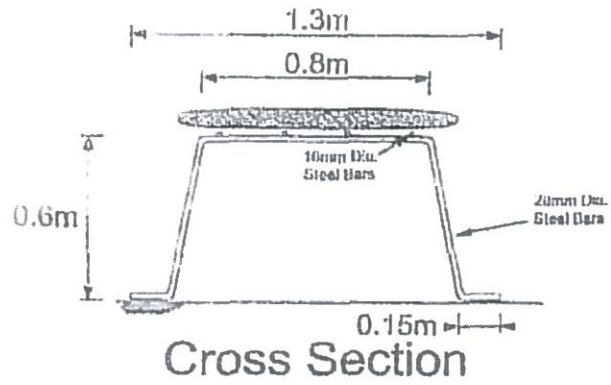

Typical Oyster Bag

SCALE 1:25

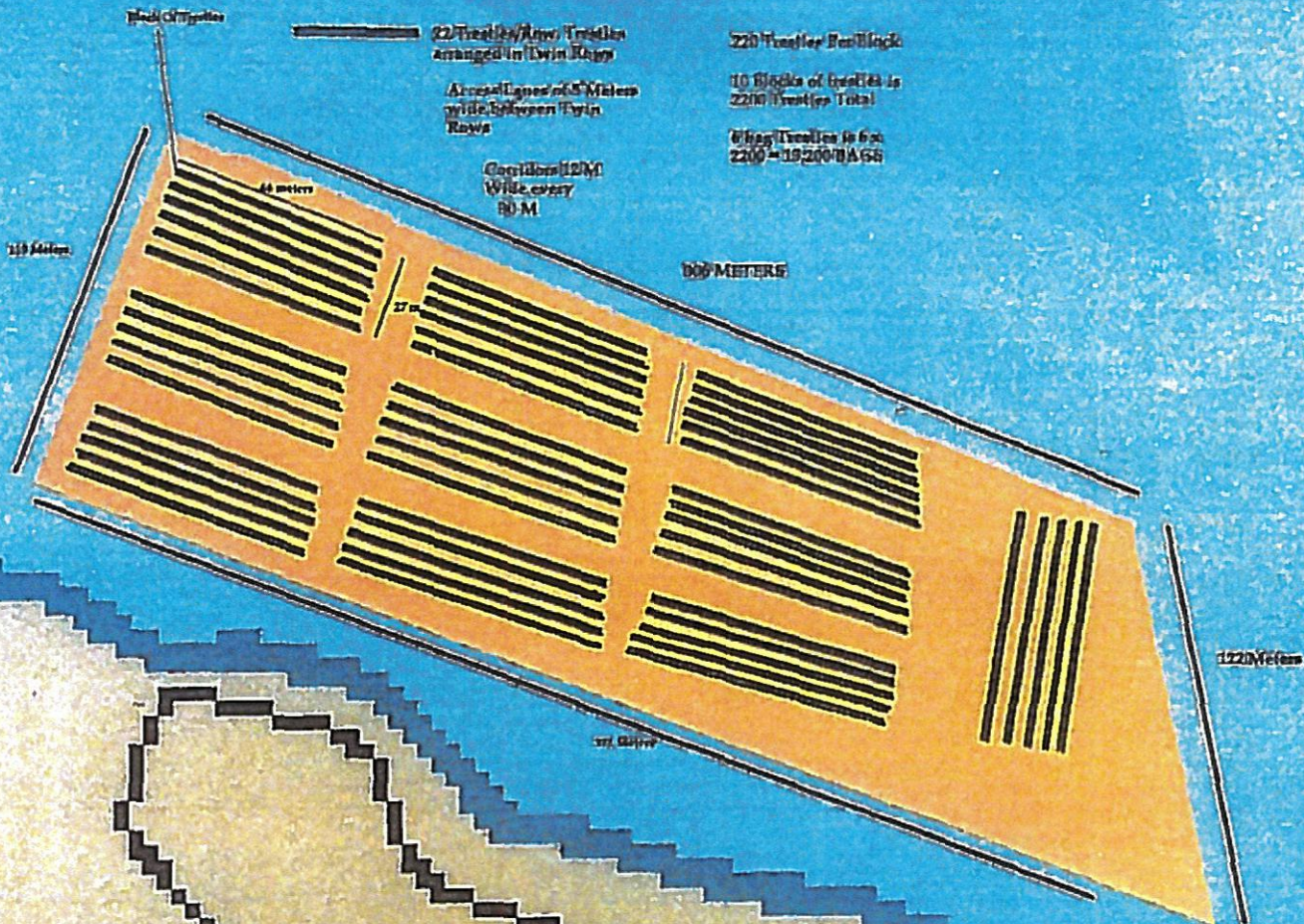

1:2,000



SCHEDULE 3

Schedule 3 contains:

- **requirements of CIL:**

That the applicant apply for Statutory Sanction from the Commissioners of Irish Lights for the aids to navigation that may be required by the Marine Survey Office. These aids should be in place before development on the site commences.

The size and specification of aids to navigation should be of the design and specification approve by Marine Survey Office (MSO) and must be agreed in advance with CIL/

- **requirements of the MSO**

The navigation marking detail:four posts, projecting two meters above sea level at highest astronomical tide and with a topmark of a diagonal St Andrew's cross, painted yellow of the appropriate standard of construction, should be erected at the four extreme points of the development.

SCHEDULE 4

Schedule 4 contains:

- **The Licensee must comply with any Code of Practice developed in agreement with NPWS.**



Department of
**Agriculture,
Food and the Marine**

An Roinn
**Talmhaíochta,
Bia agus Mara**

T11/86

FORESHORE LICENCE

**Eamonn Caffrey
9 Priory Chase
St. Raphael's Manor
Celbridge
Co. Kildare**

TABLE OF CONTENTS

TERMS AND CONDITIONS APPLICABLE TO FORESHORE LICENCE

SEAL OF OFFICE AND SIGNATURES

SCHEDULE 1

FORESHORE LICENCE IN RESPECT OF A SITE
(NUMBERED T11/86A) AT CUMMEEN STRAND, SLIGO BAY, CO SLIGO

AGREEMENT made on the 11th April 2018, between the Minister for Agriculture, Food and the Marine (hereinafter referred to as the “Minister” which expression shall include his Successors or Assigns where the contract so requires or admits), of the one part, and

Eamonn Caffrey

9 Priory Chase

St. Raphael’s Manor

Celbridge

Co. Kildare

(hereinafter referred to as the “Licensee”) of the other part, whereby the Minister, in exercise of the powers conferred on him by Section 3 of the Foreshore Act, 1933 (No.12 of 1933) hereby grants to the Licensee licence to use and occupy that part of the foreshore at Cummeen Strand, Sligo Bay, Co. Sligo (numbered T11/86A) detailed in the attached schedule and more particularly delineated on the map annexed hereto and thereon coloured red for the purpose of the cultivation set out in Aquaculture Licence Number 1119 on the terms and conditions set out in the attached pages.

This Foreshore Licence shall remain in force for a maximum period of ten (10) years commencing on 11th April 2018, provided for so long as the Aquaculture Licence Number 1119 granted on 11th April 2018 under the Fisheries (Amendment) Act 1997 (No. 23 of 1997) in respect of the same site for the purpose referred to is in force.

TERMS AND CONDITIONS APPLICABLE TO FORESHORE LICENCE

1. The Licensee shall pay to the Minister the annual sum of € 63.49 (Sixty Three euro Forty Nine cent), such payment to be made on the 11th day of April in every year during the continuance of this Licence, the first of such payments to be made on the signing hereof.
2. The Licensee shall use that part of the foreshore, the subject matter of this Licence, for the cultivation set out in Aquaculture Licence Number 1119 only and for no other purpose whatsoever.
3. The Licensee shall comply fully with all terms and conditions of Aquaculture Licence Number 1119.
4. The Licensee shall indemnify and keep indemnified the State, the Minister, his officers, servants or agents against all actions, loss, damage, costs, expenses and any demands or claims however arising in connection with the construction, maintenance or use of any structures, apparatus, equipment or any other thing used in connection with the licensed operation in the licensed area or in the exercise of the rights granted under the licence and the Licensee shall take such steps as the Minister may specify in order to ensure compliance with this condition.
5. The duty of maintenance and responsibility for the upkeep and safety of the site rests with the Licensee.
6. The Minister shall be at liberty at any time to terminate this Licence by giving to the Licensee three months notice in writing ending on any day, and upon determination of such notice, the Licence and permission granted shall be deemed to be revoked and withdrawn without the liability for the payment of any compensation by the Minister to the Licensee.
7. Any notice to be given by the Minister may be transmitted through the Post Office addressed to the Licensee at the last known address of the Licensee.
8. The Licensee shall not carry out any operations authorised by the Licence in the licensed area in such a manner as to interfere unreasonably with fishing or navigation in the vicinity of the licensed area and shall comply with any direction given to the Licensee in that regard by the Minister.
9. In the event of the breach, non-performance or non-observance by the Licensee of any of the conditions herein contained, the Minister may forthwith terminate this Licence without prior notice to the Licensee.

AND IT IS HEREBY CERTIFIED THAT:

1. For the purpose of the stamping of this Instrument that this is an Instrument to which the provisions of Section 53 of the Stamp Duties Consolidation Act 1999 (No. 31 of 1999), do not apply for the reason that the entire of the property involved comprises Foreshore and contains no Buildings.
2. The Family Law Acts of 1976, 1981, 1989, 1995 and the Family Law (Divorce) Act 1996 do not affect the Property.

SEAL OF OFFICE AND SIGNATURES

PRESENT when the Seal of Office
of the **MINISTER FOR AGRICULTURE, FOOD
AND THE MARINE**
was affixed and was authenticated
by the Signature of:

WITNESS: J. Helyard
ADDRESS: Agriculture House

OCCUPATION: CIVIL SERVANT

SIGNED on behalf of Licensee~~x~~

in the presence of:

WITNESS: Elizabeth Coffey
ADDRESS: 37 Beehive Stream, Manor.
Tim, Co. Wick.
OCCUPATION: Retired



A person so authorised under Section
15(1) of the Ministers and Secretaries
Act, 1924 to authenticate the seal of
the Minister.



SCHEDULE 1

Schedule 1 contains:

- **the co-ordinates of the site based on the Irish National Grid Co-ordinate System and the area of the site**
- **site map(s)**
- **a chart showing the location of the site in relation to the surrounding area.**

1 NO. SITE AT SLIGO HARBOUR CO.SLIGO

Co-ordinates & Area

Site T11/086A (3.626 Ha)

The area seaward of the high water mark and enclosed by a line drawn from Irish National Grid Reference point

162435, 336949 to Irish National Grid Reference point
162718, 336833 to Irish National Grid Reference point
162744, 336713 to Irish National Grid Reference point
162395, 336845 to the first mentioned point.

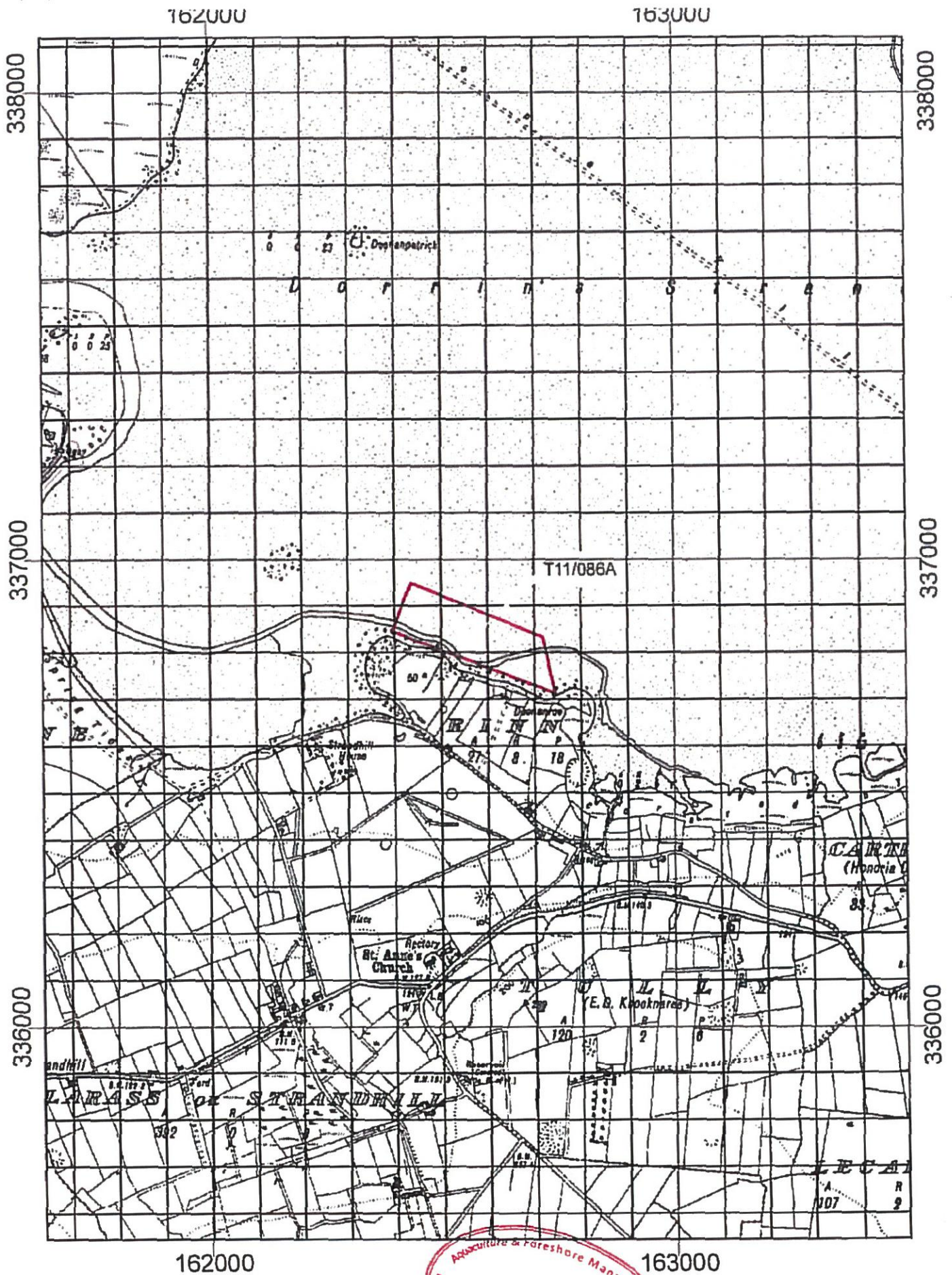

- Aqua Culture Sites**
 <all other values>
- Site_Status**
- Application
 - Lapsed
 - Licensed
 - Refused
 - Revoked
 - Surrendered
 - Withdrawn
 - 100 Meter Reference Grid

1:10,560

09 MAY 2017



Sites highlighted in red denotes Application
 Ordnance Survey Ireland Licence No. EN 6676413
 © Ordnance Survey Ireland/Government of Ireland



Department of
Agriculture, Food and the Marine
 An Roinn
Talmhaíochta, Bia agus Mara

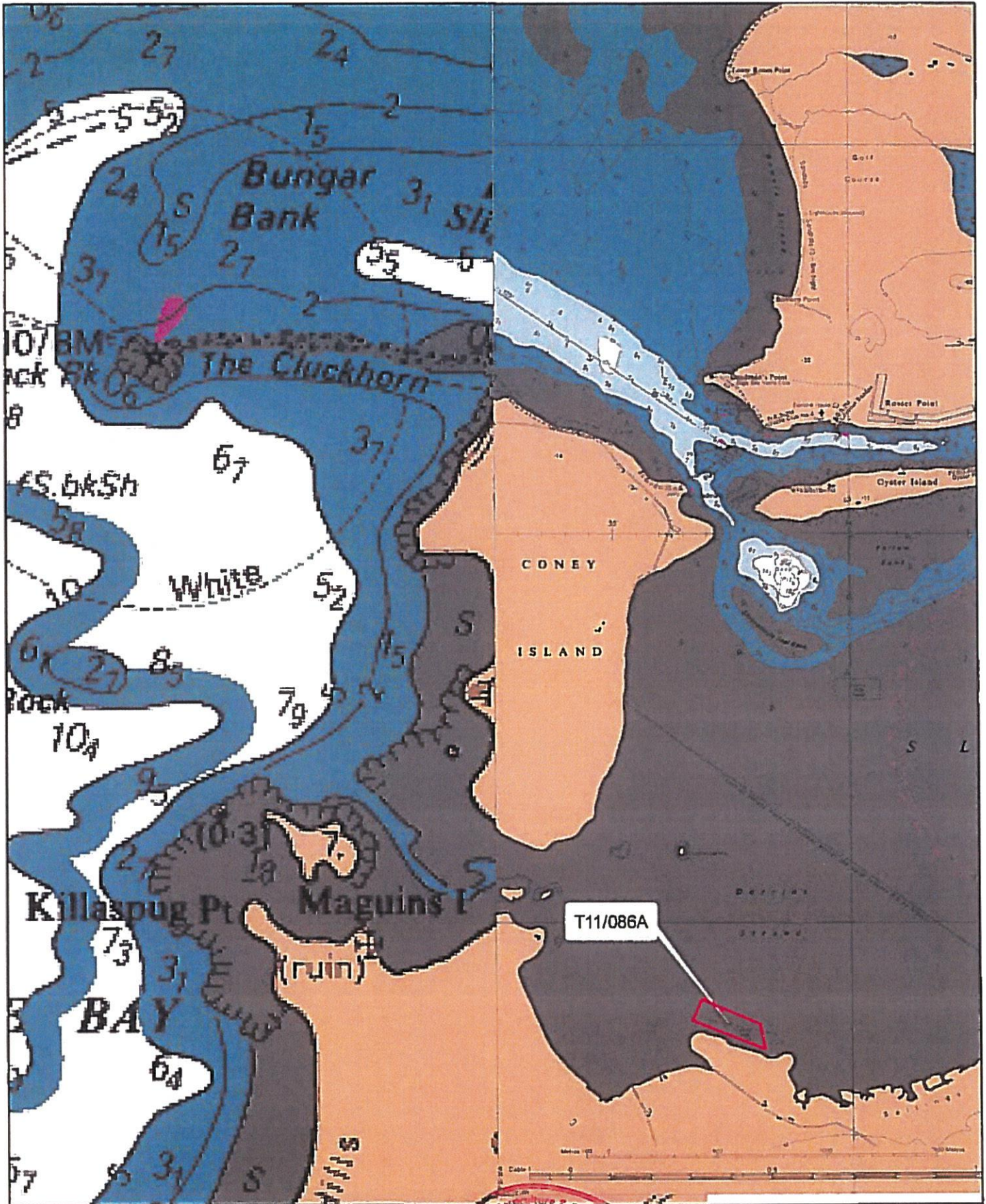

Aqua Culture Sites

- <all other values>
Site_Status
- Application
 - Lapsed
 - Licensed
 - Refused
 - Revoked
 - Surrendered
 - Withdrawn
 - 100 Meter Reference Grid

1:24,000

Sites highlighted in red denotes Application
 Part of Admiralty Chart No =2767-1,2852-1
 Not to be used for Navigation



Department of
**Agriculture,
 Food and the Marine**
 An Roinn
**Talmhaíochta,
 Bia agus Mara**