

# Conservation of Fuel and Energy – Dwellings

# L

## Building Regulations 2020

## Technical Guidance Document



**Rialtas na hÉireann**  
Government of Ireland

Prepared by the Department of Housing, Planning and Local  
Government

[housing.gov.ie](http://housing.gov.ie)

# Part L Regulations 2020

## Technical Guidance Document

### Conservation of Fuel and Energy - Dwellings

Le ceannach díreach ón  
FOILSEACHÁIN RIALTAIS  
(Teil: 076 1106834 nó 1890 213434; Fax: 076 1106843)  
nó trí aon díoltóir leabhar.

-----

To be purchased directly from  
GOVERNMENT PUBLICATIONS  
52 ST. STEPHEN'S GREEN, DUBLIN 2  
(Tel: 076 1106834 or 1890 213434; Fax: 076 1106843)  
or through any bookseller.

-----



# Contents

---

	Page
INTRODUCTION	1
TRANSITIONAL ARRANGEMENTS	1
THE GUIDANCE	2
TECHNICAL SPECIFICATIONS	2
MATERIALS AND WORKMANSHIP	3
INTERPRETATION	3
PART L - THE REQUIREMENT	4
Section 0: General Guidance	6
0.1 APPLICATION OF THE REGULATIONS	6
0.1.1 General	6
0.1.2 New dwellings	6
0.1.3 Existing dwellings	7
0.2 TECHNICAL RISKS AND PRECAUTIONS	8
0.2.1 General	8
0.2.2 Fire safety	8
0.2.3 Ventilation	8
0.3 THERMAL CONDUCTIVITY AND THERMAL TRANSMITTANCE	8
0.4 DIMENSIONS	10
0.5 DEFINITIONS	10
0.6 APPLICATION TO BUILDINGS OF ARCHITECTURAL OR HISTORICAL INTEREST	11
0.7 NEARLY ZERO ENERGY BUILDINGS (NZEBs)	12
Section 1: New Dwellings	13
1.1 LIMITATION OF PRIMARY ENERGY USE AND CO <sub>2</sub> EMISSIONS	14
1.2 RENEWABLE ENERGY TECHNOLOGIES	15
1.3 BUILDING FABRIC	17
1.3.1 General	17
1.3.2 Fabric insulation	18
1.3.3 Thermal bridging	19
1.3.4 Building envelope air permeability	20
1.3.5 Limiting Heat Gains	21
1.4 BUILDING SERVICES	22
1.4.1 General	22
1.4.2 Heat generator efficiency	22

---

1.4.3	Space heating and hot water supply system controls	22
1.4.4	Insulation of hot water storage vessels, pipes and ducts	23
1.4.5	Mechanical ventilation systems	25
1.4.6	Electric Vehicle Recharging Infrastructure	26
1.5	CONSTRUCTION QUALITY AND COMMISSIONING OF SERVICES	26
1.5.1	General	27
1.5.2	Insulation continuity and air permeability	27
1.5.3	Thermal bridging	27
1.5.4	Air permeability pressure tests	27
1.5.5	Commissioning of space and water heating systems	28
1.6	USER INFORMATION	28
	Section 2: Existing Dwellings	29
2.1	BUILDING FABRIC	30
2.1.1	General	30
2.1.2	Fabric insulation	30
2.1.3	Thermal bridging	31
2.1.4	Air permeability	32
2.2	BUILDING SERVICES	34
2.2.1	General	34
2.2.2	Heat generator efficiency	34
2.2.3	Space heating and hot water supply system controls	35
2.2.4	Insulation of hot water storage vessels, pipes and ducts	35
2.3	MAJOR RENOVATION	36
2.3.9	Electric Vehicle Recharging Infrastructure	37
	Appendices	39
A	Calculation of U-values	40
B	Fabric Insulation: Additional guidance for common constructions	52
C	Reference values for calculation of MPEPC and MPCPC	67
D	Thermal bridging at junctions and around openings	69
E	Achieving compliance with respect to EPC and CPC	83
F	Major renovations compliance examples	90
	Standards and publications	92
	Other standards and publications	96

---

## INTRODUCTION

This document has been published by the Minister for Housing, Planning and Local Government under Article 7 of the Building Regulations 1997. It provides guidance in relation to the application of Part L of the Second Schedule to the Regulations.

The guidance in this document applies to dwellings, both new and existing. The guidance in relation to the application of Part L contained in Technical Guidance Document L Conservation of Fuel and Energy - Buildings other than Dwellings applies to all other new and existing buildings.

Part L (Conservation of Fuel and Energy) of the Building Regulations and this Technical Guidance Document, provide for the implementation of the requirements of Articles 2, 3, 4, 6 (part of), 7, 8 (part of) and 9 (3(b)) of the EU Energy Performance of Buildings Directive – EPBD (recast) (2010/31/EU of 19 May 2010) and amending directive 2018/844 of 30<sup>th</sup> May 2018.

These requirements include:

- application of a methodology for the calculation of the energy performance of buildings on the basis of the general framework set out in Annex I to the EPBD (recast).
- setting of minimum energy performance requirements for buildings and the application of these requirements to new buildings to achieve Nearly Zero Energy Buildings;
- ensuring that when dwellings undergo major renovation, the energy performance of the building or the renovated part thereof is upgraded in order to meet the minimum energy performance requirements set in accordance with Article 4 in so far as this is technically, functionally and economically feasible;

- ensuring that where heat generators are replaced in an existing building, the installation of self-regulating devices for the separate regulation of the temperature in each room or, where justified, in a designated heated zone of the dwelling, is required, where technically and economically feasible;
- setting minimum electric vehicle recharging infrastructure provisions for new buildings and for buildings undergoing major renovation.

The guidance in this document also gives due regard to the cost-optimal levels of minimum energy performance requirements submitted in Ireland's report to the Commission under Article 5 of the EPBD Recast Directive 2010/31/EU of 19th May 2010.

Part L (Conservation of Fuel and Energy) of the Building Regulations and this Technical Guidance Document set the energy performance requirements to achieve Nearly Zero Energy Buildings performance as required by Article 9(1(a)) and 4(1) of the Directive 2010/31/EU for new dwellings.

This document should be read in conjunction with the Building Regulations 1997-2020 and other documents published under these Regulations.

In general, Building Regulations apply to the construction of new buildings, major renovations and to extensions and material alterations to existing buildings. In addition, certain Parts of the Regulations, including Part L, apply to existing buildings where a material change of use takes place.

## TRANSITIONAL ARRANGEMENTS

In general, this document applies to works, or dwellings in which a material alteration or change of use or major renovation commences or takes place, as the case may be, on or after ~~1<sup>st</sup> November 2019~~ 10<sup>th</sup> March 2020. Insofar as the guidance contained

---

therein relates to dwellings, Technical Guidance Document L Conservation of Fuel and Energy – Dwellings 2020 ceases to have effect from ~~31<sup>st</sup> October 2019~~ 9<sup>th</sup> March 2020. However, the foregoing document may continue to be used in the case of dwellings:

- where the works, material alteration, change of use or major renovation commences or takes place, as the case may be, on or before ~~31<sup>st</sup> October 2019~~ 9<sup>th</sup> March 2020,

or

- where:
  - a) planning approval or permission has been applied for on or before ~~31<sup>st</sup> October 2019~~ 9<sup>th</sup> March 2020 and substantial work has been completed by ~~31<sup>st</sup> October 2020~~ 10<sup>th</sup> March 2021 or;
  - b) a notice pursuant to the provisions of Part 8 of the Planning and Development Regulations 2001 (S.I. No. 600 of 2001) has been published on or before ~~31<sup>st</sup> October 2019~~ 9<sup>th</sup> March 2020 and where substantial work has been completed by ~~31<sup>st</sup> October 2020~~ 10<sup>th</sup> March 2021.

“Substantial work has been completed” means that the structure of the external walls of the ~~dwelling building~~ has been erected.

## THE GUIDANCE

The materials, methods of construction, standards and other specifications (including technical specifications) that are referred to in this document are those which are likely to be suitable for the purposes of the Building Regulations (as amended). Where works are carried out in accordance with the guidance in this document, this will, *prima facie*, indicate compliance with Part L of the Second Schedule to the Building Regulations and with the European Union (Energy Performance of Buildings) Regulations 2019.

However, the adoption of an approach other

than that outlined in the guidance is not precluded provided that the relevant requirements of the Regulations are complied with. Those involved in the design and construction of a building may be required by the relevant building control authority to provide such evidence as is necessary to establish that the requirements of the Regulations are being complied with.

## TECHNICAL SPECIFICATIONS

Building Regulations are made for specific purposes, e.g. to provide, in relation to buildings, for the health, safety and welfare of persons, the conservation of energy and access for people with disabilities.

Technical specifications (including harmonised European Standards, European Technical Assessments, National Standards and Agrément Certificates) are relevant to the extent that they relate to these considerations.

Any reference to a technical specification is a reference to so much of the specification as is relevant in the context in which it arises. Technical specifications may also address other aspects not covered by the Regulations.

A reference to a technical specification is to the latest edition (including any amendments, supplements or addenda) current at the date of publication of this Technical Guidance Document. However, if this version of the technical specification is subsequently revised or updated by the issuing body, the new version may be used as a source of guidance provided that it continues to address the relevant requirements of the Regulations.

A list of other standards and publications that deal with matters relating to this Part of the Building Regulations is included at the end of this document. These standards and publications may be used as a source of further information but do not form part of the guidance.

---

## **MATERIALS AND WORKMANSHIP**

Under Part D of the Second Schedule to the Building Regulations, building work to which the Regulations apply must be carried out with proper materials and in a workmanlike manner. Guidance in relation to compliance with Part D is contained in Technical Guidance Document D.

## **INTERPRETATION**

In this document, a reference to a section, paragraph, appendix or diagram is, unless otherwise stated, a reference to a section, paragraph, appendix or diagram, as the case may be, of this document. A reference to another Technical Guidance Document is a reference to the latest edition of a document published by the Minister for Housing, Planning and Local Government under Article 7 of the Building Regulations 1997 (as amended).

Diagrams are used in this document to illustrate particular aspects of construction - they may not show all the details of construction.



# Conservation of Fuel and Energy

---

## PART L - THE REQUIREMENT

The requirements regarding conservation of fuel and energy for dwellings and the energy performance of dwellings are laid out in Part L of the Second Schedule to the Building Regulations.

The Second Schedule to the Building Regulations, insofar as it relates to works relating to dwellings, is amended to read as follows:

- L1 A building shall be designed and constructed so as to ensure that the energy performance of the building is such as to limit the amount of energy required for the operation of the building and the amount of carbon dioxide (CO<sub>2</sub>) emissions associated with this energy use insofar as is reasonably practicable.
- L2 For existing dwellings, the requirements of L1 shall be met by:
- (a) limiting heat loss and, where appropriate, availing of heat gain through the fabric of the building;
  - (b) controlling the output of the space heating and hot water systems [and installing self-regulating devices](#), as appropriate;
  - (c) limiting the heat loss from pipes, ducts and vessels used for the transport or storage of heated water or air;
  - (d) providing that all oil and gas fired boilers installed as replacements in existing dwellings shall meet a minimum seasonal efficiency of 90 % where practicable;
  - (e) When a dwelling undergoes major renovation, the minimum energy performance requirement of the dwelling or the renovated part thereof is upgraded in order to meet the cost optimal level of energy performance in so far as this is technically, functionally and economically feasible; and
  - (f) [ensuring that for an existing multi-unit building undergoing major renovation, the installation of ducting infrastructure, namely conduits for electric cables, for every parking space to enable the installation of recharging points for electric vehicles, where:](#)
    - (i) [the car park is located inside the building, and renovations measures include the car park or the electrical infrastructure of the building; or](#)
    - (ii) [the car park is physically adjacent to the building, and renovation measures include the car park or the electrical infrastructure of the car park.](#)
- L3 For new dwellings, the requirements of L1 shall be met by:
- (a) providing that the energy performance of the building is such as to limit the calculated primary energy consumption and related carbon dioxide (CO<sub>2</sub>) to that of a nearly zero energy building within the meaning of the Directive insofar as is reasonably practicable, when both energy consumption and carbon dioxide (CO<sub>2</sub>) emissions are calculated

using the Dwelling Energy Assessment Procedure (DEAP) published by Sustainable Energy Authority of Ireland;

- (b) providing that, the nearly zero or very low amount of energy required is covered to a very significant extent by energy from renewable sources, including energy from renewable sources produced on-site or nearby;
- (c) limiting the heat loss and, where appropriate, availing of heat gain through the fabric of the building;
- (d) providing and commissioning energy efficient space and water heating systems with efficient heat sources, effective controls and self-regulating devices;
- (e) providing that all oil and gas fired boilers shall meet a minimum seasonal efficiency of 90 %;
- (f) providing to the dwelling owner sufficient information about the building, the fixed building services, controls and their maintenance requirements so that the building can be operated in such a manner as to use no more fuel and energy than is reasonable;
- (g) ensuring that for a new multi-unit building the installation of ducting infrastructure, namely conduits for electric cables, for every parking space to enable the installation of recharging points for electric vehicles, where:
  - (i) the car park is located inside the building; or
  - (ii) the car park is physically adjacent to the building; and
- (h) ensuring that for a new dwelling house with a car parking space located within the curtilage of the dwelling house, the provision of appropriate electric vehicle recharging infrastructure to enable the installation of a recharging point for electric vehicles.

# Section 0

## General Guidance

---

### 0.1 APPLICATION OF THE REGULATIONS

#### 0.1.1 General

**0.1.1.1** The aim of Part L of the Second Schedule to the Building Regulations and of the European Union (Energy Performance of Buildings) Regulations 2019 is to limit the use of energy and related carbon dioxide (CO<sub>2</sub>) emissions arising from the operation of buildings, while ensuring that occupants can achieve adequate levels of lighting and thermal comfort. Buildings should be designed and constructed to achieve this aim as far as is practicable.

**0.1.1.2** The guidance in this document applies to works to dwellings only. Guidance for buildings other than dwellings can be found in a separate Technical Guidance Document Conservation of Fuel and Energy - Buildings other than dwellings.

#### 0.1.2 New dwellings

**0.1.2.1** For new dwellings, the key issues to be addressed in order to ensure compliance are:

##### Whole dwelling performance

(a) Primary energy consumption and related CO<sub>2</sub> emissions: providing that the calculated primary energy consumption associated with the operation of the dwelling and the related CO<sub>2</sub> emissions when calculated using the Dwelling Energy Assessment Procedure (DEAP) published by the Sustainable Energy Authority of Ireland, as described in Section 1.1, do not exceed a target value specified in this document;

##### Individual minimum performance levels

The performance levels specified for items (b) to (i) below are in the nature of backstop minimum performance levels so as to ensure reasonable levels of performance for all factors affecting energy use, irrespective of

the measures incorporated to achieve compliance with Regulation 8(a).

Meeting the performance levels specified for items (b) to (j) will not necessarily mean that the level specified for primary energy consumption and related CO<sub>2</sub> emissions [item (a)] will be met. One or more of the performance levels specified, for items (b) to (j), will need to be exceeded to achieve this.

- (b) Use of renewable energy sources: providing that the contribution of renewable energy sources to the calculated primary energy requirement meets the target for such contribution as set out in Section 1.2;
- (c) Fabric insulation: providing for fabric insulation, including the limitation of thermal bridging, which satisfies the guidance in this regard as set out in Section 1.3 (sub-sections 1.3.2 to 1.3.3);
- (d) Air tightness: limiting air infiltration as set out in sub-section 1.3.4;
- (e) Heat generator: providing an efficient heat generator as set out in sub-section 1.4.2;
- (f) Building Services Controls: controlling, as appropriate, the demand for, and output of, space heating and hot water services provided, as set out in sub-section 1.4.3;
- (g) Insulation of pipes, ducts and vessels: limiting the heat loss from pipes, ducts and vessels used for the transport or storage of heated water or air, as set out in sub-section 1.4.4;
- (h) Mechanical Ventilation Systems: providing that, where a mechanical ventilation system is installed, the system meets reasonable performance levels, as set out in sub-section 1.4.5;

- 
- (i) Limiting Heat Gains: ensuring that the building is appropriately designed to limit heat gains through the fabric, as set out in sub-section 1.3.5;
  - (j) Performance of completed dwelling: ensuring that the design and construction processes are such that the completed building satisfies compliance targets and design intent. Guidance is given in Section 1.5.

### User information

- (k) Ensuring that adequate operating and maintenance instructions are available to facilitate operation in an energy efficient manner. Guidance is given in Section 1.6.

**0.1.2.2** Consideration may be given to the future upgrading of the building fabric and fixed services so as to reduce further CO<sub>2</sub> emissions associated with the operation and use of these dwellings.

**0.1.2.3** Where a dwelling has an attached room or space that is to be used for commercial purposes (e.g. workshop, surgery, consulting room or office), such room or space should be treated as part of the dwelling if the commercial part could revert to domestic use on a change of ownership, e.g. where there is direct access between the commercial space and the living accommodation, both are contained within the same thermal envelope and the living accommodation occupies a substantial proportion of the total area of the building.

Where a new dwelling forms part of a larger building, the guidance in this document applies to the individual dwelling, and the relevant guidance in Technical Guidance Document L Conservation of Fuel and Energy – Buildings other than dwellings applies to the non-dwelling parts of the building such as common areas (including common areas of apartment blocks), and in the case of mixed-use developments, the commercial or retail space.

**0.1.2.4** The guidance given in this Technical Guidance Document is generally applicable to all works associated with the construction of new dwellings. However, unheated ancillary areas, e.g. a buffer space for solar preheating of ventilation air, which are not intended for use as part of the habitable dwelling area should generally be treated as outside the area assessed in relation to energy consumption and CO<sub>2</sub> emissions (see Section 1.1). However, where such areas have the potential to become part of the habitable area, e.g. attached garages, the external fabric elements should comply with the guidance in relation to fabric insulation given in sub-sections 1.3.2 and 1.3.3.

An attached conservatory-style sunspace, or the like, forming part of a new dwelling construction should be treated as an integral part of the habitable area of the dwelling.

### 0.1.3 Existing dwellings

**0.1.3.1** This amendment applies to all works to existing dwellings that are covered by the requirements of the Building Regulations including extensions, material alterations, material changes of use, major renovation and the replacement of external doors, windows and roof lights. In carrying out this work, the aim should be to limit energy requirements for the operation of the dwelling and associated CO<sub>2</sub> emissions as far as is practicable as required by Regulation L1. The key issues to be addressed are:

- (a) Fabric insulation: providing reasonable levels of fabric insulation in all new construction, including the limitation of thermal bridging including, where provided, replacement windows and doors. Guidance is given in sub-sections 2.1.2 and 2.1.3;
- (b) Air tightness: limiting air infiltration through the newly constructed elements as far as is practicable. Guidance is given in sub-section 2.1.4;
- (c) Heat Generator: providing an efficient

---

heat generator as set out in sub-section 2.2.2;

- (d) Building Services Controls: where new space and/ or water heating services are provided, controlling, as appropriate, the demand for, and output of these space heating and hot water services. Guidance on appropriate measures is given in sub-section 2.2.3; and
- (e) Insulation of pipes, ducts and vessels: limiting the heat loss from pipes, ducts and vessels used for the transport or storage of heated water or air, as set out in sub-section 2.2.4.
- (f) When a dwelling undergoes major renovation, the energy performance of the whole dwelling should be improved to cost optimal level in so far as this is technically, functionally and economically feasible. Guidance is given in section 2.3.

## **0.2 TECHNICAL RISKS AND PRECAUTIONS**

### **0.2.1 General**

**0.2.1.1** The incorporation of additional thickness of thermal insulation and other energy conservation measures can result in changes in traditional construction practice. Appendix B contains general guidance on the construction and installation for common forms of construction for roofs, walls and floors.

**0.2.1.2** Care should be taken in design and construction to ensure that changes do not increase the risk of certain types of problems, such as rain penetration and condensation. Some guidance on avoiding such increased risk is given in Appendix B of this document. General guidance on avoiding risks that may arise is also contained in the publication "Thermal insulation: avoiding risks; Building Research Establishment (Ref BR 262)".

**0.2.1.3** Guidance in relation to particular

issues and methods of construction will be found in relevant standards.

### **0.2.2 Fire safety**

**0.2.2.1** Part B of the Second Schedule to the Building Regulations prescribes fire safety requirements. In designing and constructing buildings to comply with Part L, these requirements must be met and the guidance in relation to fire safety in Technical Guidance Document B should be fully taken into account. In particular, it is important to ensure that windows, which provide secondary means of escape in accordance with Technical Guidance Document B, comply with the dimensional and other guidance for such windows set in that document.

### **0.2.3 Ventilation**

**0.2.3.1** Part F of the Second Schedule to the Building Regulations prescribes ventilation requirements both to meet the needs of the occupants of the building and to prevent excessive condensation in roofs and roofspaces. A key aim of the provisions in relation to ventilation of occupied spaces is to minimise the risk of condensation, mould growth and/or other indoor air quality problems. In addition to meeting the requirements of Part F of the Building Regulations, the avoidance of excessive condensation requires that appropriate heating and ventilation regimes be employed in occupied dwellings.

**0.2.3.2** Part J of the Second Schedule to the Building Regulations prescribes requirements in relation to the supply of air for combustion appliances, including open-flued appliances which draw air from the room or space in which they are situated. Technical Guidance Document J provides guidance in this regard.

## **0.3 THERMAL CONDUCTIVITY AND THERMAL TRANSMITTANCE**

**0.3.1** Thermal conductivity ( $\lambda$ -value) relates to a material or substance, and is a measure of

---

the rate at which heat passes through a uniform slab of unit thickness of that material or substance, when unit temperature difference is maintained between its faces. It is expressed in units of Watts per metre per degree Kelvin (W/mK).

**0.3.2** For the purpose of showing compliance with this Part of the Building Regulations, design  $\lambda$ -values based on manufacturers declared values should be used. For thermally homogeneous materials, declared and design values should be determined in accordance with I.S. EN ISO 10456: 2007. Design values for masonry materials should be determined in accordance with I.S. EN 1745: 2012. For insulation materials, values determined in accordance with the appropriate harmonised European standard should be used. Certified  $\lambda$ -values for foamed insulant materials should take account of the blowing agent actually used. The use of HCFC for this purpose is no longer permitted.

For products or components for which no appropriate standard exists, measured values, certified by an approved body or accredited laboratory (see Technical Guidance Document D), should be used.

**0.3.3** Table A1 of Appendix A contains  $\lambda$ -values for some common building materials. These are primarily based on data contained in I.S. EN ISO 10456: 2007 or CIBSE Guide A, Appendix 3.A7. This publication also includes common values for insulation materials. The values provide a general indication of the thermal conductivity that may be expected for these materials. In the absence of declared values, design values or certified measured values as outlined in paragraph 0.3.2, values of thermal conductivity given in Table A1 may be used. However, values for specific products may differ from these illustrative values. Compliance should be verified for thermal insulation materials using thermal conductivity values derived as outlined in paragraph 0.3.2 above.

**0.3.4** Thermal transmittance (U-value) relates

to a building component or structure, and is a measure of the rate at which heat passes through that component or structure when unit temperature difference is maintained between the ambient air temperatures on each side. It is expressed in units of Watts per square metre per degree Kelvin of air temperature difference (W/m<sup>2</sup>K).

**0.3.5** Thermal transmittance values (U-values) relevant to this Part of the Regulations are those relating to elements exposed directly or indirectly to the outside air. This includes floors directly in contact with the ground, suspended ground floors incorporating ventilated or unventilated voids, and elements exposed indirectly via unheated spaces. The U-value takes account of the effect of the ground, voids and unheated spaces on the rate of heat loss, where appropriate. Heat loss through elements that separate dwellings or other premises that can reasonably be assumed to be heated, is considered to be negligible. Such elements do not need to meet any particular U-value nor should they be taken into account in the calculation of CO<sub>2</sub> emissions or overall transmission heat loss.

**0.3.6** A range of methods exist for calculating U-values of building elements. Methods of calculation are outlined in Appendix A, together with examples of their use. Alternatively U-values may be based on certified measured values. Measurements of thermal transmission properties of building components generally should be made in accordance with I.S. EN ISO 8990:1997, or in the case of windows and doors, I.S. EN ISO 12567-1:2010.

**0.3.7** Any part of a roof that has a pitch of 70° or more may be treated as a wall for the purpose of assessing the appropriate level of thermal transmission. Elements separating the building from spaces that can reasonably be assumed to be heated should not be included.

**0.3.8** Appendix B contains guidance on the construction and installation for common

---

forms of construction for roofs, walls and floors. It explains the condensation risk and gives guidance on the use of vapour control layers.

**0.3.9** NSAI S.R. 54:2014 *Code of Practice for the Energy Efficient Retrofit of Dwellings* provides technical guidance on the energy efficient retrofit of the building fabric and services, the application of retrofit measures on a whole dwelling basis, general building science and the management of retrofit projects.

## 0.4 DIMENSIONS

**0.4.1** Except where otherwise indicated linear measurements for the calculation of wall, roof and floor areas and building volumes should be taken between the finished internal faces of the appropriate external building elements and, in the case of roofs, in the plane of the insulation. Linear measurements for the calculation of the areas of external door, window and rooflight openings should be taken between internal faces of appropriate sills, lintels and reveals.

**0.4.2** "Volume" means the total volume enclosed by all enclosing elements and includes the volume of non-usable spaces such as ducts, stairwells and floor voids in intermediate floors.

## 0.5 DEFINITIONS

For the purposes of this Technical Guidance Document, the following definitions apply:

*Biomass*: Biodegradable fraction of products waste and residues from agriculture (including vegetal and animal substances), forestry and related industries, as well as the biodegradable fraction of industrial and municipal waste, used as a fuel or energy source. Fuels derived from biomass may be in solid, liquid or gas form. In this document, where the term "biomass" is used on its own, it should be taken to mean solid biomass (wood, wood chip, wood pellet, etc).

*Biofuel*: Liquid or gas fuel derived from biomass.

Note: Biomass (including biofuel) is generally included in Delivered Energy and thus, together with the energy used to produce and deliver it, included in Primary Energy.

*Delivered Energy*: Energy supplied to the building and its systems to satisfy the relevant energy uses, e.g. space heating, water heating, cooling, ventilation, lighting. Delivered Energy does not include renewable energy produced on-site. Delivered Energy differs from energy use by the extent of on-site conversion and transformation losses, e.g. boiler efficiency losses.

*Energy Use* (for a particular purpose, e.g. space heating, water heating, cooling, ventilation, lighting): Energy input to the relevant system to satisfy the relevant purpose.

*Heat pump*: is an encased assembly or assemblies designed as a unit, using a vapour compression cycle or gas absorption cycle to provide the delivery of heat.

*Major Renovation*: means the renovation of a building where more than 25 % of the surface of the building envelope undergoes renovation.

The surface area of the building thermal envelope means the entire surface area of a building through which it can lose heat to the external environment or the ground, including all heat loss areas of walls, windows, floors and roof. The surface area should be calculated as outlined in section 0.4 using internal dimensions.

*Nearly Zero-Energy Building (NZEB)*: means a building that has a very high energy performance, as determined in accordance with Annex I of the EU Energy Performance of Buildings Directive Recast (EPBD Recast) 2010/31/EU of 19th May 2010. The nearly zero or very low amount of energy required should be covered to a very significant extent

---

by energy from renewable sources, including energy from renewable sources produced on-site or nearby.

*Primary Energy:* means energy from renewable and non-renewable sources which has not undergone any conversion or transformation process.

*Renewable Energy:* Energy from renewable non-fossil energy sources, e.g. solar energy (thermal and photovoltaic), wind, hydropower, biomass, geothermal, ambient energy, wave, tidal, landfill gas, sewage treatment plant gas and biogases.

*Seasonal Efficiency:* The seasonal efficiency should be calculated as defined in DEAP.

*Seasonal space heating energy efficiency:* means the ratio between the space heating demand for a designated heating season, supplied by a heater and the annual energy consumption required to meet this demand, expressed in %.

*Technical building system:* means technical equipment for space heating, space cooling, ventilation, domestic hot water, built-in lighting, building automation and control, on-site electricity generation, or a combination thereof, including those systems using energy from renewable sources, of a building or building unit.

*Water heating energy efficiency:* means the ratio between the useful energy in the drinking or sanitary water provided by a water heater or combination heater and the energy required for its generation, expressed in %.

## **0.6 APPLICATION TO BUILDINGS OF ARCHITECTURAL OR HISTORICAL INTEREST**

**0.6.1** Part L and the European Union (Energy Performance of Buildings) Regulations do not apply to works (including extensions) to an existing building which is a “protected structure” or a “proposed protected structure” within the meaning of the Planning and

Development Act 2000 (No. 30 of 2000). Nevertheless, the application of this Part and of the European Union (Energy Performance of Buildings) Regulations may pose particular difficulties for habitable buildings which, although not protected structures or proposed protected structures, may be of architectural or historical interest including buildings of traditional construction with permeable fabric that both absorbs and readily allows the evaporation of moisture.

The aim should be to improve the energy efficiency as far as is reasonably practicable. The work should not prejudice the character of the building or increase the risk of long term deterioration of the building fabric.

I.S. EN 16883:2017, *Conservation of cultural heritage – Guidelines for improving the energy performance of historic buildings* provides guidelines for sustainably improving the energy performance of historic buildings, e.g. historically, architecturally or culturally valuable buildings, while respecting their heritage significance.

**0.6.2** Works such as the replacement of doors, windows and rooflights, the provision of internal and/ or external insulation and damp-proofing to walls and basements, insulation to the underside of slating and provision of roof vents and ducting of pipework could all affect the character of the structure.

**0.6.3** In general, the type of works described above should be carefully assessed for their material and visual impact on the structure.

**0.6.4** Historical windows and doors should be repaired rather than replaced, and internal insulation and damp-proofing should not disrupt or damage historic plasterwork or flagstones and should not introduce further moisture into the structure.

**0.6.5** Roof insulation should be achieved without damage to slating (either during the works or from erosion due to condensation)



---

and obtrusive vents should not affect the character of the roof.

**0.6.6** In specific cases including replacement of historical windows and insulation of vapour permeable constructions, relaxation of the values proposed may be acceptable to the local building control authority, if it can be shown to be necessary in order to preserve the architectural and historical integrity of the particular building.

**0.6.7** In specific cases, services and their controls can play a large part in improving energy efficiency. In most traditional buildings, building services such as heating systems, plumbing and electrical installations are not original to the building and there may therefore be some flexibility in altering them.

**0.6.8** For more guidance on appropriate measures see “Architectural Heritage Protection - Guidelines for Planning Authorities” by the Department Arts, Heritage and the Gaeltacht and “Energy Efficiency in Traditional Buildings” by the Department of the Environment, Heritage and Local Government.

## **0.7 NEARLY ZERO ENERGY BUILDINGS (NZEBS)**

**0.7.1** In order to achieve the acceptable primary energy consumption rate for a nearly zero energy dwelling, the calculated energy performance coefficient (EPC) of the dwelling being assessed should be no greater than the Maximum Permitted Energy Performance Coefficient (MPEPC). The MPEPC for a nearly zero energy dwelling is 0.30.

**0.7.2** To demonstrate that an acceptable CO<sub>2</sub> emission rate has been achieved for a nearly zero energy dwelling, the calculated carbon performance coefficient (CPC) of the dwelling being assessed should be no greater than the Maximum Permitted Carbon Performance Coefficient (MPCPC). The MPCPC for a nearly zero energy dwelling is 0.35.

# Section 1

## New Dwellings

---

- L1 A building shall be designed and constructed so as to ensure that the energy performance of the building is such as to limit the amount of energy required for the operation of the building and the amount of carbon dioxide (CO<sub>2</sub>) emissions associated with this energy use insofar as is reasonably practicable.
- L3 For new dwellings, the requirements of L1 shall be met by:
- (a) providing that the energy performance of the building is such as to limit the calculated primary energy consumption and related carbon dioxide (CO<sub>2</sub>) to that of a nearly zero energy building within the meaning of the Directive insofar as is reasonably practicable, when both energy consumption and carbon dioxide (CO<sub>2</sub>) emissions are calculated using the Dwelling Energy Assessment Procedure (DEAP) published by Sustainable Energy Authority of Ireland;
  - (b) providing that, the nearly zero or very low amount of energy required is covered to a very significant extent by energy from renewable sources, including energy from renewable sources produced on-site or nearby;
  - (c) limiting the heat loss and, where appropriate, availing of heat gain through the fabric of the building;
  - (d) providing and commissioning energy efficient space and water heating systems with efficient heat sources, effective controls and self-regulating devices;
  - (e) providing that all oil and gas fired boilers shall meet a minimum seasonal efficiency of 90 %;
  - (f) providing to the dwelling owner sufficient information about the building, the fixed building services, controls and their maintenance requirements so that the building can be operated in such a manner as to use no more fuel and energy than is reasonable;
  - (g) ensuring that for a new multi-unit building the installation of ducting infrastructure, namely conduits for electric cables, for every parking space to enable the installation of recharging points for electric vehicles, where:
    - (i) the car park is located inside the building; or
    - (ii) the car park is physically adjacent to the building; and
  - (h) ensuring that for a new dwelling house with a car parking space located within the curtilage of the dwelling house, the provision of appropriate electric vehicle recharging infrastructure to enable the installation of a recharging point for electric vehicles.

---

## 1.1 LIMITATION OF PRIMARY ENERGY USE AND CO<sub>2</sub> EMISSIONS

**1.1.1** This Section provides guidance on how to show compliance with the requirements in relation to primary energy consumption and CO<sub>2</sub> emissions specified in Regulation 8(a) of the European Union (Energy Performance of Building) Regulations 2019. The methodology for calculation to be used is specified in the Regulation as the DEAP methodology. This methodology is published by the Sustainable Energy Authority of Ireland (SEAI) and calculates the energy consumption and CO<sub>2</sub> emissions associated with a standardised use of a dwelling and standardised external environmental conditions. The energy consumption is expressed in terms of kilowatt hours per square metre floor area per year (kWh/m<sup>2</sup>/yr) and the CO<sub>2</sub> emissions expressed in terms of kilograms of CO<sub>2</sub> per square metre floor area per year (kg CO<sub>2</sub>/m<sup>2</sup>/yr). Full details of the methodology are available on the SEAI website at <http://www.seai.ie>. The DEAP manual, also available on that website, describes the DEAP methodology. The calculation is based on the energy balance taking into account a range of factors that contribute to annual energy usage and associated CO<sub>2</sub> emissions for the provision of space heating, cooling, water heating, ventilation and lighting of a dwelling. These factors include:

- size, geometry and exposure of the dwelling;
- materials used for construction of the dwelling;
- thermal insulation of the different elements of the building fabric;
- ventilation characteristics of the dwelling and ventilation equipment;
- efficiency, responsiveness and control characteristics of the heating system(s);

- solar gains through glazed openings of the dwelling;
- thermal storage (mass) capacity of the dwelling;
- the fuel used to provide space and water heating, ventilation and lighting;
- renewable and alternative energy generation technologies incorporated in the dwelling;
- air permeability of the dwelling.

**1.1.2** The performance criteria are based on the relative values of the calculated primary energy consumption and CO<sub>2</sub> emissions of a dwelling being assessed, and similar calculated values for a reference dwelling. Details of the reference dwelling are given in Appendix C. The criteria are determined as follows:

- primary energy consumption and CO<sub>2</sub> emissions for both the proposed dwelling and the reference dwelling are calculated using DEAP.
- the calculated primary energy consumption of the proposed dwelling is divided by that of the reference dwelling, the result being the energy performance coefficient (EPC) of the proposed dwelling. To demonstrate that an acceptable primary energy consumption rate has been achieved, the calculated EPC of the dwelling being assessed should be no greater than the Maximum Permitted Energy Performance Coefficient (MPEPC). The MPEPC is 0.3. This coefficient represents the numerical indicator for the energy performance of Nearly Zero Energy Dwellings.
- the calculated CO<sub>2</sub> emission rate of the proposed dwelling is divided by that of the reference dwelling, the result being the carbon performance coefficient (CPC) of the proposed dwelling. To demonstrate that an acceptable CO<sub>2</sub>

---

emission rate has been achieved, the calculated CPC of the dwelling being assessed should be no greater than the Maximum Permitted Carbon Performance Coefficient (MPCPC).

The MPCPC is 0.35. This coefficient represents the numerical indicator for the CO<sub>2</sub> emission rate for Nearly Zero Energy Dwellings.

The DEAP software will calculate the EPC and CPC of the dwelling being assessed and clearly indicate whether compliance with the requirements of Regulation 8(a) has been achieved.

**1.1.3** Where a building contains more than one dwelling (such as in a terrace of houses or a block of apartments), reasonable provision would be to show that:

- every individual dwelling has an EPC and CPC no greater than the MPEPC and MPCPC respectively; or
- the average EPC and CPC for all dwellings in the building is no greater than the MPEPC and MPCPC respectively.

Where the latter approach is used, the average EPC and CPC are calculated by multiplying the EPC and CPC for each individual dwelling by the floor area of that dwelling, adding together and dividing the results by the sum of the floor areas of all dwellings. Common areas in the building are not included in this calculation.

**1.1.4** The requirements that the calculated EPC and CPC do not exceed the calculated MPEPC and MPCPC respectively, applies to the constructed dwelling. It is considered good practice for designers to calculate the EPC and CPC at early design stage in order to ensure that the requirements can be achieved by the constructed building. It is also open to professional bodies or other industry interests to develop model dwelling designs that can

confidently be adopted without the need to calculate the EPC and CPC at design stage. However, the use of constructions and service systems which have been assessed at design stage, or other model designs, does not preclude the need to verify compliance by calculating the EPC and CPC when all relevant details of the final construction are known.

**1.1.5** The use of renewable and low carbon technologies, such as solar hot water, biomass (e.g. wood and wood pellets) and heat pumps, whether provided to meet the requirements of this Part of the Building Regulations (see Section 1.2) or provided as additional to meeting that requirement, can facilitate compliance with the requirements in relation to primary energy use and CO<sub>2</sub> emissions. As defined, primary energy does not include energy derived from on-site renewable energy technologies. In addition, as renewable energy technologies are generally characterised by zero, or greatly reduced CO<sub>2</sub> emissions, the calculated EPC and CPC are reduced by the extent that they replace traditional fossil fuels. As the performance of the reference dwelling (see Appendix C) is not affected by the incorporation of these technologies in a dwelling being assessed, this has the effect of making it easier to achieve compliance with this Part of the Building Regulations when these technologies are used.

For certain dwelling types, use of renewables may prove the most practical approach to achieving compliance. The use of centralised renewable energy sources contributing to a heat distribution system serving all dwelling units in a development or apartment block may prove to be more practicable than providing separate renewable energy for each dwelling individually.

## **1.2 RENEWABLE ENERGY TECHNOLOGIES**

**1.2.1** This section gives guidance on the minimum level of renewable technologies to

---

be provided to show compliance with Regulation 8(b) of the European Union (Energy Performance of Buildings) Regulations 2019.

**1.2.2.** Renewable Energy Ratio (RER) is the ratio of the primary energy from renewable energy technologies to total primary energy as defined and calculated in DEAP.

For the purposes of this Section, “renewable energy technologies” means technology, products or equipment that supply energy derived from renewable energy sources, e.g. solar thermal systems, solar photovoltaic systems, biomass systems, systems using biofuels, heat pumps, aerogenerators and other small scale renewable systems.

**1.2.3** Where the MPEPC of 0.3 and MPCPC of 0.35 are achieved, a RER of 0.20 represents a very significant level of energy provision from renewable energy technologies.

A RER of 0.2 represents 20 % of the primary energy from renewable energy technologies to total primary energy as defined and calculated in DEAP.

**1.2.4** Where a building contains more than one dwelling, reasonable provision would be to show that:

- every individual dwelling should meet the minimum provision from renewable energy technologies specified in paragraph 1.2.3 above; or
- the average contribution of renewable technologies to all dwellings in the building should meet that minimum level of provision per dwelling.

Where there are both common areas and individual dwellings in a building, reasonable provision would be to show that the average contribution of renewable technologies to all areas meets the minimum level of renewable provision to the individual dwellings and

common areas combined. In this case, a proportion of the renewables should be provided to each area and individual dwelling in the building.

**1.2.5** In the case of heat pumps, DEAP sets the procedure to calculate the renewable energy provision for use in the Renewable Energy Ratio. In the case of systems based on biofuels or biomass, appliances must be designed to run on these fuels only, i.e. incapable of providing thermal energy from fossil fuels, to be accepted as renewable technology for the purposes of this Regulation. For example, a boiler which could operate on either oil or a biofuel mixture would not be considered to be a renewable technology. Similarly a boiler capable of utilizing coal or peat, in addition to a biomass fuel would not be considered a renewable technology.

**1.2.6** The use of centralised renewable energy sources contributing to a heat distribution system serving all dwelling units in a district, an area, a development or part of a development, e.g. an apartment block, may prove to be more practicable than providing separate renewable energy for each dwelling individually and may be counted towards the Renewable Energy Ratio.

**1.2.7** As an alternative to providing the RER (Renewable Energy Ratio) as outlined in sub-section 1.2.2, the use of a combined heat and power (CHP) system that contributes to the space and water heating energy use would be acceptable.

The primary energy savings due to the use of CHP should be equivalent to the RER of 0.20 contributing to the thermal energy use within the building. The calculation methodology for the primary energy saving contribution is provided in the DEAP calculation.

The design of the CHP system should take account of the output rating of the appliance and the design thermal profile for the development for which it is designed.

---

It should be suitable for the building application (simultaneous electrical and thermal profile requirements) and not oversized.

Further guidance with regards to the design of CHP systems is available in CIBSE Manual AM 12 Combined Heat and Power in Buildings for both high-density developments and individual dwellings.

Section 4.4 of CIBSE Manual AM 12 details an operating model for CHP sizing and recommends the use of an hour-by-hour model over a whole year with heat and electricity demand profiles representing an average year.

**1.2.8** Part D of the Building Regulations requires that all works be carried out with proper materials and in a workmanlike manner. “Materials” includes products, components and items of equipment, and guidance is provided on how products, components and items of equipment can be shown to be “proper materials”. Renewable technologies should satisfy the requirements of Part D in the same way as other construction products and materials. A range of standards applicable to renewable energy technologies are given in the “Other standards and publications” Section in this document.

For specific renewable technologies, the SEAI maintain databases of acceptable products together with information on relevant performance characteristics. Products listed in these databases may be assumed to be “proper materials” for the purposes of this Part of the Building Regulations. Databases exist for:

- solar thermal systems;
- wood pellet stoves;
- wood pellet/chip boilers;
- heat pumps.

**1.2.9** To ensure that works are carried out in a “workmanlike manner”, the design and installation of renewable energy systems to comply with this guidance should be carried out by a person qualified to carry out such work. A suitably qualified installer should have achieved Quality and Qualifications Ireland (QQI) or equivalent certification from an accredited training course in each of the technology areas they wish to work in. Qualified installers may include SEAI registered installers, Solas trained plumbers or Solas trained electricians, who have completed an appropriate renewable technology module, or similar.

**1.2.10** Detailed guidance on the specification of renewable technologies for dwellings is contained in the Technical Guidance Document supporting document “Heating and Domestic Hot Water Systems for Dwellings – Achieving compliance with Part L and Energy Performance of Buildings Regulations 2019” (to be published) and the National Standards Authority of Ireland’s NSAI S.R.50-2: 2012, *Code of practice for building services - Part 2: Solar panels*.

## **1.3 BUILDING FABRIC**

### **1.3.1 General**

**1.3.1.1** This section gives guidance on acceptable levels of provision to ensure that heat loss through the fabric of a dwelling is limited insofar as reasonably practicable. Guidance is given on three main issues:

- insulation levels to be achieved by the plane fabric elements (sub-section 1.3.2);
- thermal bridging (sub-section 1.3.3); and
- limitation of air permeability (sub-section 1.3.4).

**1.3.1.2** Unheated areas which are wholly or largely within the building structure, do not have permanent ventilation openings and are not otherwise subject to excessive air-

infiltration or ventilation, e.g. common areas such as stairwells, corridors in buildings containing flats, may be considered as within the insulated fabric. In that case, if the external fabric of these areas is insulated to the same level as that achieved by equivalent adjacent external elements, no particular requirement for insulation between a heated dwelling and unheated areas would arise, subject to achieving the EPC and CPC requirements. It should be noted that heat losses to such unheated areas are taken into account by the DEAP methodology in the calculation of the dwelling EPC and CPC (see Section 1.1).

### 1.3.2 Fabric insulation

**1.3.2.1** The derivation of U-values, including those applicable where heat loss is to an unheated space, is dealt with in paragraphs 0.3.4 to 0.3.8 and Appendix A.

**1.3.2.2** In order to limit heat loss through the building fabric reasonable provision should be made to limit transmission heat loss by plane elements of the building fabric. Acceptable levels of thermal insulation for each of the plane elements of the building to achieve this are specified in terms of average area-weighted U-value ( $U_m$ ) in Table 1 (Column 2) for each fabric element type. These values can be relaxed for individual elements or parts of elements where considered necessary for design or construction reasons. Maximum acceptable values for such elements or parts of elements are specified in Table 1 (Column 3). Where this relaxation is availed of, the average area-weighted values given in Column 2 continue to apply and compensatory insulation measures may be necessary for other elements or parts of elements of that type to ensure that these are met. Where the source of space heating is underfloor heating, the maximum floor U-value should be  $0.15 \text{ W/m}^2\text{K}$ .

**1.3.2.3** Reasonable provision would also be achieved if the total heat loss through all the opaque elements did not exceed that which would be the case if each of the area-

weighted average U-value ( $U_m$ ) set out in Table 1 were achieved individually. Where this approach is chosen, the values for individual elements or sections of elements given in Table 1 (Column 3) also apply. For ground floors or exposed floors incorporating underfloor heating, the guidance in paragraph 1.3.2.2 applies.

**1.3.2.4** The area of openings should not be reduced below that required for the provision of adequate daylight. BS 8206-2:2008 *Code of Practice for daylighting* and CIBSE Lighting Guide LG 10 gives advice on adequate daylight provision.

**1.3.2.5** Diagram 1 summarises the minimum fabric insulation standards applicable.

Column 1 Fabric Elements	Column 2 Area-weighted Average Elemental U-value ( $U_m$ )	Column 3 Average Elemental U-value - individual element or section of element
Roofs		
Pitched roof		
- Insulation at ceiling	0.16	0.3
- Insulation on slope	0.16	
Flat roof	0.20	
Walls	0.18	0.6
Ground floors <sup>3</sup>	0.18	0.6
Other exposed floors	0.18	0.6
External doors, windows and rooflights	1.4 <sup>4,5</sup>	3.0
Notes:		
1. The U-value includes the effect of unheated voids or other spaces.		
2. For alternative method of showing compliance see paragraph 1.3.2.3.		
3. For insulation of ground floors and exposed floors incorporating underfloor heating, see paragraph 1.3.2.2.		
4. Windows, doors and rooflights should have a maximum U-value of $1.4 \text{ W/m}^2\text{K}$ .		
5. The NSAI Window Energy Performance Scheme (WEPS) provides a rating for windows combining heat loss and solar transmittance. The solar transmittance value $g_{\text{perp}}$ measures the solar energy through the window.		

### 1.3.3 Thermal bridging

**1.3.3.1** To avoid excessive heat losses and local condensation problems, reasonable care should be taken to ensure continuity of insulation and to limit local thermal bridging at key junctions, e.g. around windows, doors, other wall openings and at junctions between elements. Any thermal bridge should not pose a risk of surface or interstitial condensation. Appendix D.2 provides further information on assessing surface condensation risk and

Appendix B.3 provides information on assessing interstitial condensation risk.

Heat loss associated with thermal bridges is taken into account in calculating energy use and CO<sub>2</sub> emissions using the DEAP methodology. See Appendix D for further information in relation to thermal bridging and its effect on dwelling heat loss and how this is taken account of in DEAP calculations.

**Diagram 1** Average Area Weighted Elemental U-values  
(Par. 1.3.2.2)

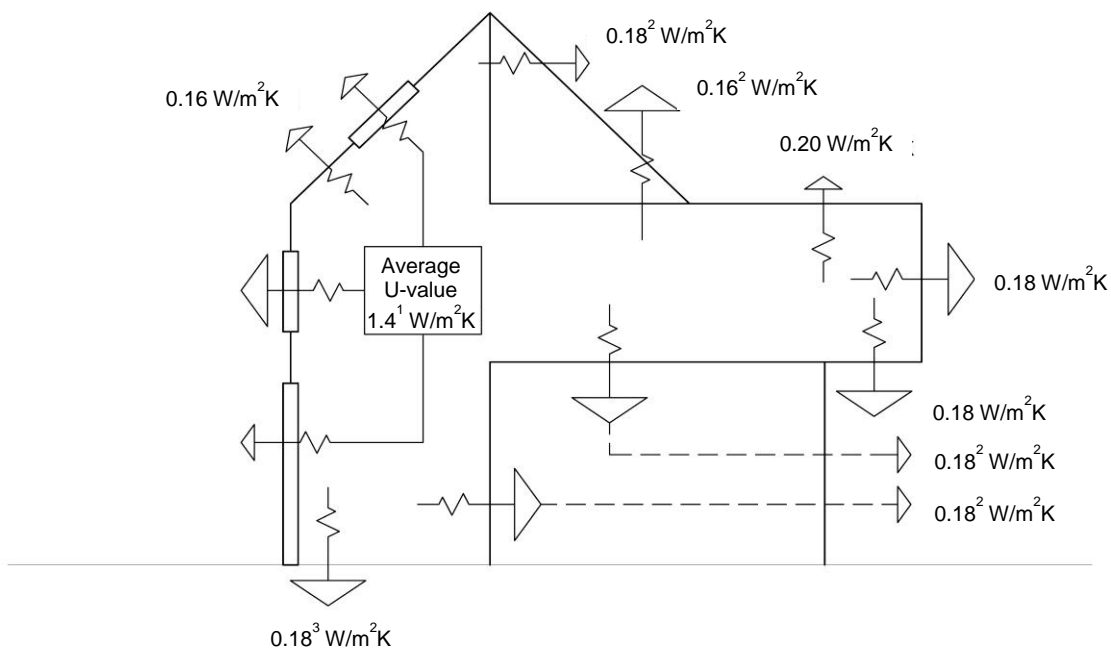

**Notes:**

Average U-values of all elements may vary as set out in paragraph 1.3.2.3.

1. The average U-value of 1.4W/m²K for windows, doors and rooflights applies.

2. The U-values include the effect of unheated voids and other spaces.

3. This U-value applies to unheated floors. Where the source of space heating is underfloor heating, the maximum floor U-value should be 0.15 W/m²K (see paragraph 1.3.2.2).

**1.3.3.2** The following represents alternative approaches to making reasonable provision with regard to limitation of thermal bridging:

(i) adopt Acceptable Construction Details for typical constructions as shown in sections 1 to 6 in the document "Limiting



---

Thermal Bridging and Air Infiltration – Acceptable Construction Details” for all key junctions;

- (ii) adopt Acceptable Construction Details sections 1 to 6 combined with details from Appendix 2 of the document “Limiting Thermal Bridging and Air Infiltration – Acceptable Construction Details” or other certified details (as defined in (iii) below) for all key junctions;
- (iii) use certified details which have been assessed in accordance, and comply with Appendix D, e.g. certified by a third party certification body such as Agrément or equivalent or certified by a member of an approved thermal modelers scheme or equivalent for all key junctions;
- (iv) use alternative details which limit the risk of mould growth and surface condensation to an acceptable level as set out in paragraph D.2 of Appendix D for all junctions.

Irrespective of which approach is used, appropriate provision for on-site inspection and related quality control procedures should be made (see sub-sections 1.5.2 and 1.5.3).

**1.3.3.3** The DEAP calculation of primary energy use and CO<sub>2</sub> emissions (see Section 1.1) takes account of thermal bridging effects. In general this is done by including an allowance for additional heat loss due to thermal bridging, expressed as a multiplier applied to the total exposed surface area or by the calculation of the transmission heat loss coefficient  $H_{TB}$ .

Where provision for thermal bridging is made in accordance with option (i) of paragraph 1.3.3.2, this multiplier ( $\gamma$ ) may be taken as 0.08 or the transmission heat loss coefficient ( $H_{TB}$ ) can be calculated for each of the key junctions for the specific dwelling using the psi values given in Tables D1 to D6 in Appendix D.

Where provision for thermal bridging is made in accordance with option (ii) of paragraph 1.3.3.2, the transmission heat loss coefficient ( $H_{TB}$ ) should be calculated using the psi values associated with the specific details adopted (i.e. Tables D1 to D6 and Appendix 2 of “Limiting Thermal Bridging and Air Infiltration – Acceptable Construction Details” or other certified Psi values).

Where provision for thermal bridging is made in accordance with option (iii) of paragraph 1.3.3.2, the transmission heat loss coefficient ( $H_{TB}$ ) should be calculated using the psi values associated with the certified specific details adopted.

Where provision for thermal bridging is made in accordance with option (iv) of paragraph 1.3.3.2, this multiplier ( $\gamma$ ) should be taken as 0.15.

As an alternative to all of the above, the value 0.15 may be used for the multiplier ( $\gamma$ ) providing the details used limit the risk of mould growth and surface condensation to an acceptable level as set out in paragraph D.2 of Appendix D for all junctions.

The calculation of transmission heat loss ( $H_{TB}$ ) coefficient is explained in paragraph D.3 of Appendix D, and in Appendix K of the DEAP manual.

A detailed example of a ( $\gamma$ ) value calculation using option (i) of 0.05 is provided in Appendix D, Table D7.

The DEAP Methodology provides a software tool to calculate the ( $\gamma$ ) value with ACDs and/or custom junctions.

### **1.3.4 Building envelope air permeability**

**1.3.4.1** To avoid excessive heat losses, reasonable care should be taken to limit the air permeability of the envelope of each dwelling. In this context, envelope is the total area of all floors, walls (including windows and

---

doors) and ceilings bordering the dwelling, including elements adjoining other heated or unheated spaces.

High levels of infiltration can contribute to uncontrolled ventilation. Infiltration is unlikely to provide adequate ventilation as required in the correct location.

It is important, as air permeability is reduced, that adequate purpose designed ventilation is provided.

Technical Guidance Document F provides guidance for adequate ventilation for buildings.

**1.3.4.2** The following represents a reasonable approach to the design and construction of dwellings to ensure acceptable levels of air permeability:

- (a) identify the primary air barrier elements, (e.g. sheathing, plaster, vapour control layer, breather membrane) at early design stage;
- (b) develop appropriate details and performance specification to ensure continuity of the air barrier. Communicate these to all those involved in the construction process. Responsibility for construction of details should be established;
- (c) provide on-site inspection regime and related quality control procedures so as to ensure that the design intention is achieved in practice.

**1.3.4.3** Achievement of reasonable levels of air permeability can be facilitated by adopting the standard details referred to in paragraph 1.3.3.2 above, together with an appropriate performance specification and the on-site inspection regime and related quality control procedures, referred to in that paragraph.

Alternative approaches to element design, details and quality control procedures may

also be acceptable, provided it can be shown that these approaches provide an equivalent level of performance, as if the standard details, performance specification and quality control procedures referred to above were adopted.

**1.3.4.4** Air pressure testing should be carried out on all dwellings on all development sites. See sub-section 1.5.4 for details of the test procedure, use of test results in DEAP calculations and appropriate measures to be undertaken where the limit set is not achieved. When tested in accordance with the procedure referred to in sub-section 1.5.4, a performance level of  $5 \text{ m}^3/(\text{h.m}^2)$  represents a reasonable upper limit for air permeability.

### **1.3.5 Limiting Heat Gains**

**1.3.5.1** Guidance is provided in DEAP for carrying out overheating assessment.

Reasonable provision to limit heat gains can be demonstrated by showing through the DEAP calculation that the dwelling does not have a risk of high internal temperatures. (revised DEAP methodology to be published).

Where an overheating risk is indicated in DEAP, further guidance is provided in CIBSE TM 59 to ensure overheating is avoided for normally occupied naturally ventilated spaces.

**1.3.5.2** CIBSE TM 37 provides the following recommendations and further guidance to reduce or avoid solar overheating:

(a) *Layout*: planning the layout and orientation of buildings and rooms to maximise the benefits of sunlight and minimise the disadvantages.

(b) *Solar shading*: this may include external, internal or mid-pane shading devices, or solar control glazing.

(c) *Thermal mass*: an exposed heavyweight structure, with a long response time, will tend

---

to absorb heat, resulting in lower peak temperatures on hot days. Night-time venting and acoustic requirements should also be considered.

(d) *Good ventilation*: a reasonable level of ventilation will always be required in buildings to maintain indoor air quality. The ability to switch to a much higher air change rate can be a very effective way to control solar overheating, e.g. cross ventilation, stack ventilation or mechanical ventilation.

(e) *Reducing internal gains*: by the use of e.g. energy efficient equipment, lamps, luminaires and controls.

## 1.4 BUILDING SERVICES

### 1.4.1 General

**1.4.1.1** Regulation 8(d) requires that space and water heating systems in dwellings be energy efficient, with efficient heat sources and effective controls **including self-regulating devices**. More specifically, Regulation 8(e) provides that oil or gas fired boilers must achieve a minimum seasonal efficiency of 90 %. This Section gives guidance for dwellings where the main space and water heating is based on pumped low temperature hot water systems, utilising radiators for space heating and incorporating a hot water cylinder for the storage of domestic hot water. Guidance is given on three main issues:

- (a) heat generator efficiency (sub-section 1.4.2);
- (b) space heating and hot water supply system controls (sub-section 1.4.3); and
- (c) insulation of hot water storage vessels, pipes and ducts (sub-section 1.4.4).

**1.4.1.2** This Section also contains guidance in relation to the energy efficiency aspects of:

- (a) biomass independent boilers (paragraph

1.4.2.3); and

- (b) mechanical ventilation systems, (sub-section 1.4.5)

where provided.

### 1.4.2 Heat generator efficiency

**1.4.2.1** The appliance or appliances provided to service space heating and hot water systems should be as efficient in use as is reasonably practicable. For fully pumped hot water-based central heating systems utilising oil or gas, the boiler seasonal efficiency should be not less than 90 % as specified in the DEAP manual and the associated Home-heating Appliance Register of Performance (HARP) database maintained by the SEAI ([www.seai.ie/harp](http://www.seai.ie/harp)).

**1.4.2.2** For fully pumped hot water-based central heating systems heat pumps, the seasonal space heating energy efficiency and water heating energy efficiency should not be less than the minimum requirements in accordance with Ecodesign regulations.

**1.4.2.3** For fully pumped hot water-based central heating systems utilising a biomass independent boiler, the boiler seasonal efficiency should not be less than 77 % as specified in the DEAP manual and the associated Home-heating Appliance Register of performance (HARP) database maintained by the SEAI ([www.seai.ie/harp](http://www.seai.ie/harp)).

**1.4.2.4** Guidance for minimum efficiencies for other heat generating appliances can be found in Heating and Domestic Hot Water Systems for Dwellings – Achieving compliance with Part L and Energy Performance of Buildings Regulations 2019 (to be published).

### 1.4.3 Space heating and hot water supply system controls

**1.4.3.1** Space and water heating systems should be effectively controlled so as to ensure the efficient use of energy by limiting

---

the provision of heat energy use to that required to satisfy user requirements, insofar as is reasonably practicable. The aim should be to provide the following minimum level of control:

- automatic control of space heating on the basis of room temperature;
- automatic control of heat input to stored hot water on the basis of stored water temperature;
- separate and independent automatic time control of space heating and hot water;
- shut down of boiler or other heat source when there is no demand for either space or water heating from that source.

The guidance in paragraphs 1.4.3.2 to 1.4.3.5 below is specifically applicable to fully pumped hot water-based central heating systems using gas, oil or biomass boilers.

The minimum requirements for controls for heating systems using heat pumps are set out in Tables 2 and 3.

The minimum requirements for controls for all other heating systems are set out in Heating and Domestic Hot Water Systems for Dwellings – Achieving compliance with Part L and Energy Performance of Buildings Regulations 2019 (to be published).

**1.4.3.2** Provision should be made to control heat input on the basis of temperature within the heated space, e.g. by the use of room thermostats, thermostatic radiator valves, or other equivalent form of sensing device. For larger dwellings, independent temperature control should generally be provided for separate zones that normally operate at different temperatures, e.g. living and sleeping zones. Thermostats should be located in a position representative of the temperature in the area being controlled and which is not unduly influenced by draughts, direct sunlight or other factors which would

directly affect performance. Depending on the design and layout of the dwelling, control on the basis of a single zone will generally be satisfactory for smaller dwellings. For larger dwellings, e.g. where floor area exceeds 100m<sup>2</sup>, independent temperature control on the basis of two independent zones will generally be appropriate. In certain cases, additional zone control may be desirable, e.g. zones which experience significant solar or other energy inputs may be controlled separately from zones not experiencing such inputs.

**1.4.3.3** Hot water storage vessels should be fitted with thermostatic control that shuts off the supply of heat when the desired storage temperature is reached.

**1.4.3.4** Separate and independent time control for space heating and for heating of stored water should be provided. Independent time control of space heating zones is appropriate where independent temperature control applies.

**1.4.3.5** The operation of controls should be such that the oil or gas boiler is switched off when no heat is required for either space or water heating, i.e. boiler interlock. Systems controlled by thermostatic radiator valves should be fitted with flow control or other equivalent device to ensure boiler switch off.

#### **1.4.4 Insulation of hot water storage vessels, pipes and ducts**

**1.4.4.1** All hot water storage vessels, pipes and ducts associated with the provision of heating and hot water in a dwelling should be insulated to prevent heat loss. Hot water pipes and ducts within the normally heated area of the dwelling that contribute to the heat requirement of the dwelling do not require insulation (except those referred to in paragraph 1.4.4.4). Pipes and ducts which are incorporated into wall, floor or roof construction should be insulated.

**1.4.4.2** Adequate insulation of hot water storage vessels can be achieved by the use of a storage vessel with factory applied insulation of such characteristics that, when tested on a 120 litre cylinder complying with I.S. 161: 1975 using the method specified in Annex B of BS 1566-1:2002+A1:2011, standing heat losses are restricted to 0.8 W/litre. Use of a storage vessel with 50mm, factory applied coating of PU-foam having zero ozone depletion potential and a minimum density of 30kg/m<sup>3</sup> satisfies this criterion when installed within the normally heated area of the dwelling. Alternative insulation measures giving equivalent performance may also be used.

**Table 2**  
**Minimum Controls for DHW and space heating for ground-to-water, water-to-water and air-to-water Heat Pump**

- a. Heat pump unit controls should include:
- Control of water pump operation (internal and external as appropriate);
  - Control of water temperature for the distribution system;
  - Control of outdoor fan operation for air-to-water units;
  - Defrost control of external airside heat exchanger for air-to-water systems;
  - Protection for water flow failure;
  - Protection for water high temperature;
  - Protection for high refrigerant pressure;
  - Protection of airflow failure on air-to-water units.
- b. External controls should include:
- Weather compensation or internal temperature control;
  - Timer or programmer for space heating.
- c. Minimum heat pump flow rates or volume requirements should be met. If all zones are thermostatically controlled, then a buffer would be an acceptable method of compliance.
- d. For larger dwellings e.g. where floor area exceeds 100 m<sup>2</sup>, independent temperature control on the basis of two independent zones will generally be appropriate. In certain cases, additional zone control may be desirable, e.g. zones which experience significant solar or other energy inputs may be controlled separately from zones not experiencing such inputs.
- e. Separate and independent time control for space heating and for heating of stored water should be provided. Independent time control of space heating zones is appropriate where independent temperature control applies.
- f. The domestic hot water system should have temperature control e.g. a tank thermostat, and time control to optimise the time taken to heat the water. Controls should include an auxiliary heating regime to 60°C or more for disinfection purposes.
- g. The heat pump may be utilised for all or part of the DHW load. During the DHW heating period the heat pump may not necessarily be providing heated water to the space heating system.

**Table 3**  
**Minimum controls for DHW and space-heating for ground-to-air, water-to-air and air-to-air heat pump systems**

- a. Heat pump unit controls should include:
- Control of room air temperature (if not provided externally);
  - Control of outdoor fan operation for air-to-air units;
  - Defrost control of external airside heat exchanger for air-to-air systems;
  - Control for secondary heating (if fitted) on air-to-air systems;
  - Control of external water pump operation for ground-to-air and water-to-air systems;
  - Protection for high refrigerant pressure;
  - Protection for indoor air flow failure;
  - Protection for external air flow failure on air-to-air units;
  - Protection for water flow failure on ground-to-air and water-to-air systems.
- b. External controls should include:
- Weather compensation or internal temperature control;
  - Timer or programmer for space heating.
- c. Minimum heat pump flow rates or volume requirements should be met. If all zones are thermostatically controlled, then a buffer would be an acceptable method of compliance.

**1.4.4.3** Unless the heat loss from a pipe or duct carrying hot water contributes to the useful heat requirement of a room or space, the pipe or duct should be insulated. The following levels of insulation should suffice:

- (a) pipe or duct insulation meeting the recommendations of BS 5422:2009 Methods of specifying thermal insulating materials for pipes, ductwork and equipment (in the temperature range - 40 °C to + 700 °C); or
- (b) insulation with material of such thickness that gives an equivalent reduction in heat loss as that achieved using material

having a thermal conductivity at 40 °C of 0.035 W/mK and a thickness equal to the outside diameter of the pipe, for pipes up to 40 mm diameter, and a thickness of 40 mm for larger pipes.

**1.4.4.4** The primary flow and return from the heat generator to the heat exchanger should be insulated. The hot pipes connected to hot water storage vessels, including the vent pipe, should be insulated for at least one metre from their point of connection. All insulation of pipes should be to the standard outlined in paragraph 1.4.4.3 above.

**1.4.4.5** It should be noted that water pipes and storage vessels in unheated areas will generally need to be insulated for the purpose of protection against freezing. Guidance on suitable protection measures is given in Technical Guidance Document G and Report BR 262 Thermal insulation: avoiding risks, published by BRE.

#### **1.4.5 Mechanical ventilation systems**

**1.4.5.1** Guidance on good practice with regard to energy efficiency of dwelling ventilation systems is contained in GPG 268 Energy efficient ventilation in dwellings – a guide for specifiers, available from the SEAL.

**1.4.5.2** Where a mechanical ventilation system designed for continuous operation (with or without heat recovery) is installed for the provision of ventilation to a dwelling or significant part thereof, the system should meet the performance levels specified in GPG 268 and also have specific fan power and heat recovery efficiency backstop values where appropriate not worse than those given in Table 4. Performance data for mechanical ventilation systems from system manufacturers for use in DEAP should be in compliance with the DEAP methodology.

The effectiveness of mechanical ventilation systems improve as air permeability values decrease. Air permeability values of less than 3 m<sup>3</sup>/(hr.m<sup>2</sup>) at 50 Pa are recommended in

dwellings with mechanical ventilation, especially ventilation systems with heat recovery.

Table 4 does not apply to fans installed for intermittent use in individual rooms.

<b>Table 4 Minimum performance levels for mechanical ventilation systems</b>	
<b>System type</b>	<b>Performance</b>
Maximum Specific Fan Power (SFP) for continuous supply only and continuous extract only	0.6 W/litre/sec
Maximum SFP for balanced systems	1.2 W/litre/sec <sup>1</sup>
Minimum Heat recovery efficiency	70 %
<sup>1</sup> For balanced systems with heating coils, add 0.3 W/litre/sec	

### 1.4.6 Electric Vehicle Recharging Infrastructure

1.4.6.1 For new multi-unit buildings ducting infrastructure, namely conduits for electric cables, should be provided for every parking space, to enable the installation of recharging points for electric vehicles where:

- the car park is located inside the building, e.g. a basement car park; and/ or
- the car park is physically adjacent to the building, i.e. the car park is within the curtilage of the site.

Where a new multi-unit building contains mixed uses, i.e. dwellings and non-dwellings, the minimum recharging infrastructure provisions for each use should be provided. Guidance on appropriate ducting infrastructure is provided in Paragraph 1.4.6.3.

1.4.6.2 For a new dwelling house with a car parking space located within the curtilage of the dwelling house, electric vehicle recharging infrastructure should be provided for the future installation of an electric vehicle recharging point. Guidance on appropriate

infrastructure is provided in Paragraph 1.4.6.4.

### 1.4.6.3 Multi-unit Building Ducting Infrastructure

Ducting infrastructure includes all electrical containment, e.g. cable ducting systems, cable ladders, cable trays, cable trunking systems, conduit, etc. as outlined in the National Rules for Electrical Installations I.S. 10101:20XX.

Where ducting infrastructure is installed the guidance below should be followed:

(a) ducting infrastructure should be adequately designed to meet the full capacity of all recharging points when installed;

(b) ducting infrastructure should be appropriately sized for electric vehicle recharging point capacity;

(c) ducting infrastructure should be fit for purpose, capped as appropriate and clearly identified;

(d) ducting infrastructure should be routed back to a suitable location with electrical supply access and adequate space provided to accommodate all recharging point ducting connections and electrical supply equipment;

(e) ducting infrastructure and associated electrical equipment, etc. should be adequately designed for maintenance access; and

(f) ducting infrastructure, including associated electrical equipment, etc. should be installed in accordance with the general wiring rules and safety requirements as outlined in I.S. 10101:20XX.

---

#### 1.4.6.4 Dwelling House Electric Vehicle Recharging Infrastructure

Adequate provision to enable the installation of an electric vehicle recharging point should include appropriate electric vehicle recharging infrastructure to the car parking space. The infrastructure should be installed in accordance with I.S. 10101:20XX.

Appropriate electric vehicle recharging infrastructure should provide a safe, unobstructed route, e.g. ducting infrastructure, from a metered electrical supply point to a future recharging point location, to enable the installation of an electric vehicle recharging point without the need for builders work.

The full installation of an electric vehicle recharging point can be considered to provide appropriate electric vehicle recharging infrastructure where installed.

### 1.5 CONSTRUCTION QUALITY AND COMMISSIONING OF SERVICES

#### 1.5.1 General

**1.5.1.1** The requirements of Part L and of the European Union (Energy Performance of Buildings) Regulations 2019 apply to the completed building. Reasonable measures should be taken during construction and appropriate checks and assessments carried out prior to completion to ensure that compliance with Part L and the European Union (Energy Performance of Buildings) Regulations is achieved. Sub-sections 1.5.2 to 1.5.4 give guidance on appropriate measures to satisfy this requirement.

#### 1.5.2 Insulation continuity and air permeability

**1.5.2.1** The elements that comprise the external fabric of the building should be designed and constructed to ensure that the calculated performance of the building and of its components is achieved in practice. Changes made during design and construction

should be assessed for their impact on insulation performance and on air permeability. Those not directly involved in the installation of insulation should be fully aware of the importance of not reducing the effectiveness of the installed insulation through removal or damage. On-site quality control should include checks on the adequacy of insulation installation and of any barriers designed to limit air permeability, including an inspection of finished work to ensure that all work is properly constructed before covering over.

#### 1.5.3 Thermal bridging

**1.5.3.1** There should be no reasonably avoidable thermal bridging, e.g. due to gaps between insulation layers and at joints, junctions and edges around openings. Where unavoidable thermal bridging is provided for in the design, care should be taken to ensure that the chosen design detail is accurately constructed on site.

#### 1.5.4 Air permeability pressure tests

**1.5.4.1** Air permeability can be measured by means of pressure testing of a building prior to completion. The procedure for testing is specified in I.S. EN ISO 9972:2015 Thermal performance of buildings - determination of air permeability of buildings - fan pressurization method. Additional guidance on testing procedure is given in NSAI Agrément Approval Scheme for certified air tightness testers scheme master document to I.S. EN ISO 9972:2015 Thermal performance of buildings - determination of air permeability of buildings - fan pressurization method. The preferred test method is that controllable ventilator grills should be temporarily sealed rather than just closed. Two sets of measurements should be made for pressurisation and depressurisation. Permeability is calculated by dividing the air leakage rate in m<sup>3</sup>/hr by the envelope area in m<sup>2</sup>. The performance is assessed at 50 Pa pressure difference. It has been empirically determined that for dwellings generally, the permeability at 50 Pa pressure difference is



---

approximately 20 times the air change rate at normal conditions. Guidance on appropriate extent of testing is given in paragraph 1.5.4.3.

**1.5.4.2** Air pressure testing should be carried out on all dwellings on all development sites including single dwelling developments, as outlined in paragraphs 1.5.4.3 to 1.5.4.5 to show attainment of backstop value of 5 m<sup>3</sup>/hr/m<sup>2</sup>. The tests should be carried out by a person certified by an independent third party to carry out this work, e.g. Irish National Accreditation Board (INAB), National Standards Authority of Ireland (NSAI) certified or equivalent. The test report should contain at least the information specified in Section 7 of I.S. EN 9972:2015.

**1.5.4.3** If the measured air change rates are not worse than the criterion set out in paragraph 1.3.4.4, the test results should be taken as satisfactory evidence that the requirements of Regulation 8(c), insofar as it relates to air tightness, has been demonstrated for this dwelling type. If satisfactory performance is not achieved in a particular test, then remedial measures should be carried out on the test dwelling and a new test carried out. This should be repeated until the dwelling achieves the criterion set out in paragraph 1.3.4.4.

**1.5.4.4** Where the air permeability assumed for the DEAP calculations is better than the value derived from pressure test results, a check calculation should be carried out to show that the calculated EPC and CPC using the measured air permeability (after any remedial works to satisfy paragraph 1.3.4.4, if such are necessary) are not worse than the MPEPC and MPCPC respectively. If necessary, additional remedial works or other measures should be carried out to ensure that this criterion is also met. Where further remedial works to reduce air permeability are undertaken, a further test would be necessary to verify the revised air permeability figure to be used in revised DEAP calculations.

**1.5.4.5** Air pressurisation test reports should

be retained by the developer of the dwelling as proof of performance, and copies included in the user information referred to in Section 1.6.

### **1.5.5 Commissioning of space and water heating systems**

**1.5.5.1** The heating and hot water system(s) should be commissioned so that at completion, the system(s) and their controls are left in the intended working order and can operate efficiently for the purposes of the conservation of fuel and energy. The procedure for carrying out commissioning of these systems is set out in Heating and Domestic Hot Water Systems for Dwellings – Achieving compliance with Part L and Energy Performance of Buildings Regulations 2019 (to be published).

## **1.6 USER INFORMATION**

**1.6.1** The owner of the building should be provided with sufficient information about the building, the fixed building services and their maintenance requirements so that the building can be operated in such a manner as to use no more fuel and energy than is reasonable in the circumstances. A way of complying would be to provide a suitable set of operating and maintenance instructions aimed at achieving economy in the use of fuel and energy in a way that householders can understand. The instructions should be directly related to the particular system(s) installed in the dwelling. Without prejudice to the need to comply with health and safety requirements, the instructions should explain to the occupier of the dwelling how to operate the system(s) efficiently. This should include:

- (a) the making of adjustments to the timing and temperature control settings;
- (b) what routine maintenance is needed to enable operating efficiency to be maintained at a reasonable level through the service life(lives) of the system(s); and

---

(c) the operation and maintenance of renewable energy systems.

## Section 2

### Existing Dwellings

---

- L1 A building shall be designed and constructed so as to ensure that the energy performance of the building is such as to limit the amount of energy required for the operation of the building and the amount of carbon dioxide (CO<sub>2</sub>) emissions associated with this energy use insofar as is reasonably practicable.
- L2 For existing dwellings, the requirements of L1 shall be met by:
- (a) limiting heat loss and, where appropriate, maximising heat gain through the fabric of the building;
  - (b) controlling the output of the space heating and hot water systems and installing self-regulating devices, as appropriate;
  - (c) limiting the heat loss from pipes, ducts and vessels used for the transport or storage of heated water or air;
  - (d) providing that all oil and gas fired boilers installed as replacements in existing dwellings shall meet a minimum seasonal efficiency of 90 % where practicable;
  - (e) When a dwelling undergoes major renovation, the minimum energy performance requirement of the dwelling or the renovated part thereof is upgraded in order to meet the cost optimal level of energy performance in so far as this is technically, functionally and economically feasible; and
  - (f) ensuring that for an existing multi-unit building undergoing major renovation the installation of ducting infrastructure, namely conduits for electric cables, for every parking space to enable the installation of recharging points for electric vehicles, where:
    - (i) the car park is located inside the building, and renovations measures include the car park or the electrical infrastructure of the building; or
    - (ii) the car park is physically adjacent to the building, and renovation measures include the car park or the electrical infrastructure of the car park.

---

## 2.1 BUILDING FABRIC

### 2.1.1 General

**2.1.1.1** This section gives guidance on acceptable levels of provision to ensure that heat loss through fabric elements provided by way of extension, material alteration, material change of use to an existing dwelling is limited insofar as is reasonably practicable. Guidance is given on three main issues:

- insulation levels to be achieved by the plane fabric elements (sub-section 2.1.2);
- thermal bridging (sub-section 2.1.3); and
- limitation of air permeability (sub-section 2.1.4).

Where a material change of use of an existing building to use as a dwelling occurs, the performance of the fabric elements of the newly provided dwelling should also meet the performance levels specified in this sub-section.

**2.1.1.2** This Part of the Building Regulations and the European Union (Energy Performance of Buildings) Regulations 2019 applies to the replacement of external doors, windows, or rooflights in an existing building. The average U-value of replacement units should not exceed the value of 1.4 W/m<sup>2</sup>K set out in Table 5. In this context, the repair or renewal of parts of individual elements, e.g. window glass, window casement sash, door leaf, should be considered as repair and not replacement.

**2.1.1.3** Unheated areas which are wholly or largely within the building structure, do not have permanent ventilation openings and are not otherwise subject to excessive air-infiltration or ventilation, e.g. common areas such as stairwells, corridors in buildings containing flats, may be considered as within the insulated fabric. In that case, if the external fabric of these areas is insulated to the same level as that achieved by equivalent adjacent external elements, no particular

requirement for insulation between a heated dwelling and unheated areas would arise.

**2.1.1.4** The derivation of U-values, including those applicable where heat loss is to an unheated space, is dealt with in paragraphs 0.3.4 to 0.3.8 and Appendix A.

### 2.1.2 Fabric insulation

#### Extensions

**2.1.2.1** Acceptable levels of thermal insulation for each of the plane elements of the building are specified in terms of average area-weighted U-value (U<sub>m</sub>) in Table 1 (Column 2) for each fabric element type for extensions and these values can be relaxed for individual elements or parts of elements where considered necessary for design or construction reasons. Maximum acceptable values for such elements or parts of elements are specified in Table 1 (Column 3). Where this relaxation is availed of, the average area-weighted values given in Table 1 continue to apply and compensatory insulation measures may be necessary for other elements or parts of elements of that type to ensure that these are met. Where the source of space heating is underfloor heating, the maximum floor U-value should be 0.15 W/m<sup>2</sup>K. Further guidance in relation to insulation of floors where underfloor heating is proposed is contained in the document Heating and Domestic Hot Water Systems for Dwellings – Achieving compliance with Part L and Energy Performance of Buildings Regulations 2019 (to be published).

**2.1.2.2** For extensions, reasonable provision would also be achieved if the total heat loss through all the opaque elements did not exceed that which would be the case if each of the area-weighted average U-value (U<sub>m</sub>) set out in Table 1 were achieved individually. Where this approach is chosen, the values for individual elements or sections of elements given in Table 1 (Column 3) apply to each relevant element. For ground floors or exposed floors incorporating underfloor heating, the guidance in paragraph 2.1.2.1

applies.

**2.1.2.3** The area of openings should not be reduced below that required for the provision of adequate daylight. BS 8206: Part 2: 2008 Code of practice for daylighting and CIBSE Lighting Guide LG 10 for daylight gives advice on adequate daylight provision.

**2.1.2.4** For extensions which:

- are thermally separated from the adjacent spaces within the building by walls, doors and other opaque or glazed elements which have U-values not more than 10 % greater than corresponding exposed areas of the main dwelling, and
- are unheated or, if provided with a heating facility, have provision for automatic temperature and on-off control independent of the heating provision in the existing building,

the average U-value of these elements should not exceed the value of 1.40 W/m<sup>2</sup>K.

### Material Alterations and Material Change of Use

**2.1.2.5** Acceptable levels of thermal insulation for each of the plane elements of the building are specified in terms of average area-weighted U-value (Um) for material alterations and material changes of use, as specified in column 2, Table 5. These values can be relaxed for individual elements or parts of elements where considered necessary for design or construction reasons. Maximum acceptable values for such elements or parts of elements are specified in column 3, Table 5. Where this relaxation is availed of, the average area-weighted values given in Table 5 continue to apply and compensatory insulation measures may be necessary for other elements or parts of elements of that type to ensure that these are met. Where the source of space heating is underfloor heating, the maximum floor U-value should be 0.15 W/m<sup>2</sup>K. Further guidance in relation to insulation of floors

where underfloor heating is proposed is contained in the document Heating and Domestic Hot Water Systems for Dwellings – Achieving compliance with Part L and Energy Performance of Buildings Regulations 2019 (to be published).

<b>Table 5 Maximum elemental U-value (W/m<sup>2</sup>K)<sup>1, 2,6</sup> for Material Alterations or Material Change of Use</b>		
<b>Column 1 Fabric Elements</b>	<b>Column 2 Area-weighted Average Elemental U-value (Um)</b>	<b>Column 3 Average Elemental U-value - individual element or section of element</b>
Roofs		
Pitched roof		
- Insulation at ceiling	0.16	0.35
- Insulation on slope	0.25	
Flat roof	0.25	
Walls		
Cavity walls <sup>4</sup>	0.55	0.6
Other walls	0.35	
Ground floors <sup>3</sup>	0.45 <sup>5</sup>	
Other exposed floors <sup>3</sup>	0.25	0.6
External doors, windows and rooflights and curtain walling	1.40	3.0
Notes:		
1. The U-value includes the effect of unheated voids or other spaces.		
2. For material alterations, the U-values relate to the new works.		
3. For insulation of ground floors and exposed floors incorporating underfloor heating, see paragraph 2.1.2.2.		
4. This only applies in the case of a wall suitable for the installation of cavity insulation. Where this is not the case it should be treated as for "other walls".		
5. This U-value only applies where floors are being replaced.		
6. For buildings of architectural or historical interests or permeable traditional construction, refer to paragraph 0.6.		

### 2.1.3 Thermal bridging

**2.1.3.1** To avoid excessive heat losses and local condensation problems, reasonable care should be taken to ensure continuity of insulation and to limit local thermal bridging, e.g. around windows, doors and other wall openings, at junctions between elements and other locations. Any thermal bridge should

---

not pose a risk of surface or interstitial condensation. See Appendix D for further information in relation to thermal bridging and its effect on dwelling heat loss.

**2.1.3.2** Reasonable provision with regard to limitation of thermal bridging for extensions is to adopt Acceptable Construction Details for typical constructions as shown in the document Limiting Thermal Bridging and Air Infiltration – Acceptable Construction Details (to be published) and in Annex H of NSAI S.R. 54:2014 Code of Practice for the Energy Efficient Retrofit of Dwellings or other details that are similar or that have been assessed as limiting thermal bridging to an equivalent level.

**2.1.3.3** For material alterations or material change of use, lintel, jamb and sill designs similar to those shown in Annex H of NSAI S.R. 54:2014 Code of Practice for the Energy Efficient Retrofit of Dwellings would be satisfactory.

**2.1.3.4** For material alterations or material change of use, care should be taken to control the risk of thermal bridging at the edges of floors where the floor is being replaced. The insulation should have minimum thermal resistance of 0.7 m<sup>2</sup>K/W (25 mm of insulation with thermal conductivity of 0.035 W/mK, or equivalent).

#### **2.1.4 Air permeability**

**2.1.4.1** For extensions to existing dwellings, reasonable levels of air permeability can be achieved by adopting the standard details referred to in paragraph 2.1.3.2 above, together with an appropriate performance specification and the on-site inspection regime and related quality control procedures as referred to in sub-sections 1.5.2 and 1.5.3. Alternative approaches to element design, details and quality control procedures may also be acceptable, provided it can be shown that these approaches are equivalent.

**2.1.4.2** For material alterations or material

change of use, infiltration of cold outside air should be limited by reducing unintentional air paths as far as is practicable. Measures to ensure this include:

- (a) sealing the void between dry-lining and masonry walls at the edges of openings such as windows and doors, and at the junctions with walls, floors and ceilings e.g. by continuous bands of bonding plaster or battens;
- (b) sealing vapour control membranes in timber-frame constructions;
- (c) fitting draught-stripping in the frames of openable elements of windows, doors and rooflights;
- (d) sealing around loft hatches; and
- (e) ensuring boxing for concealed services is sealed at floor and ceiling levels and sealing piped services where they penetrate or project into hollow constructions or voids.

Information and illustrations on sealing service penetrations and airtightness membranes can be found in the Introduction Section of Acceptable Construction Details and Diagram 2.

Care should be taken to ensure compliance with the ventilation requirements of Part F and of Part J of the Building Regulations.

**Diagram 2 Air infiltration measures**  
(Par. 2.1.4.1)

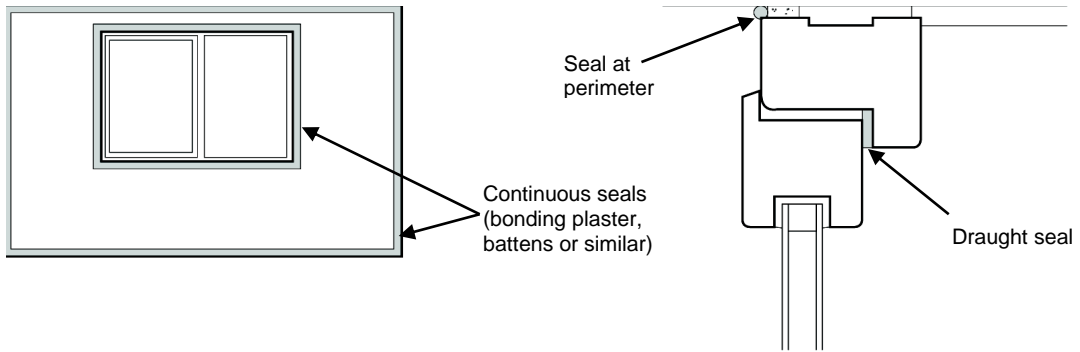

1. POSITION OF CONTINUOUS SEALING BANDS FOR DRY-LININGS FIXED TO MASONRY WALLS

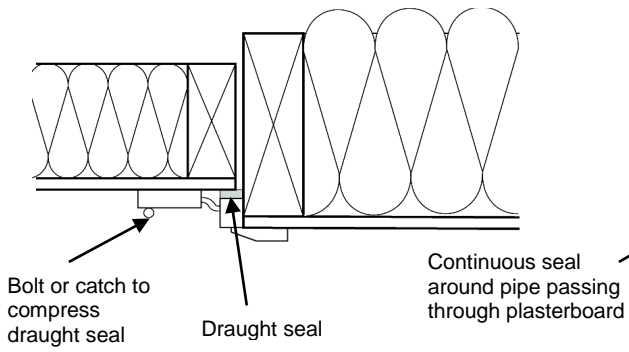

2. SEALING AT WINDOWS AND DOORS

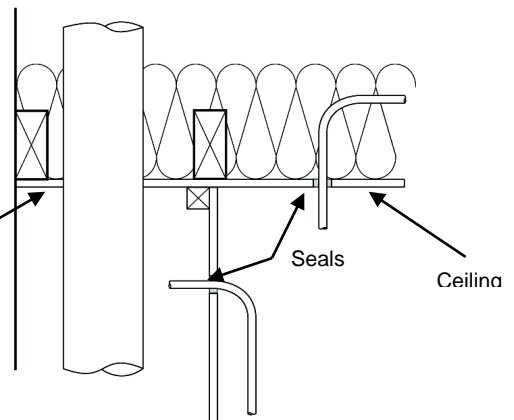

3. SEALING ACCESS HATCH

4. SEALING AROUND SERVICE PIPES

---

## 2.2 BUILDING SERVICES

### 2.2.1 General

**2.2.1.1** Space and water heating systems provided in the context of material alterations to existing dwellings or extensions to existing dwellings should be energy efficient and have efficient heat sources and effective controls including self-regulating devices. Similar considerations apply to space and water heating systems provided in the context of a material change of use of an existing building to use as a dwelling. Specifically, Regulation L2(d) provides that oil or gas fired boilers installed as replacements in existing dwellings should have a minimum seasonal efficiency of 90 %, where practicable.

This Section gives guidance where the main space and water heating is based on pumped low temperature hot water systems. Guidance is given on three main issues:

- (a) heat generator efficiency (sub-section 2.2.2);
- (b) space heating and hot water supply system controls (sub-section 2.2.3); and
- (c) insulation of hot water storage vessels, pipes and ducts (sub-section 2.2.4).

Detailed guidance for dwellings using a wide range of space and water heating systems is contained in a supporting document Heating and Domestic Hot Water Systems for Dwellings – Achieving compliance with Part L and Energy Performance of Buildings Regulations 2019 (to be published).

**2.2.1.2** This Section also contains guidance in relation to the energy efficiency aspects of biomass independent boilers (paragraph 2.2.2.4) where provided.

### 2.2.2 Heat Generator efficiency

**2.2.2.1** The appliance or appliances provided to service space heating and hot water systems should be as efficient in use as is

reasonably practicable. Guidance on appropriate efficiency for various systems and fuels is contained in Heating and Domestic Hot Water Systems for Dwellings – Achieving compliance with Part L and Energy Performance of Buildings Regulations 2019 (to be published). For fully pumped hot water-based central heating systems utilising oil or gas, the boiler seasonal efficiency should be not less than 90 % as specified in the DEAP manual and the associated Home-heating Appliance Register of Performance (HARP) database maintained by the SEAI ([www.seai.ie/harp](http://www.seai.ie/harp)). Effectively this requires the use of condensing boilers. In a limited number of situations involving replacement of existing boilers, provision of a condensing boiler may not be practicable. Detailed guidance on the assessment of specific situations to identify those where provision of condensing boilers is not practicable is given in “Heating and Domestic Hot Water Systems for Dwellings – Achieving compliance with Part L and Energy Performance of Buildings Regulations 2019” (to be published).

**2.2.2.2** For fully pumped hot water-based central heating systems heat pumps, the seasonal space heating energy efficiency and water heating energy efficiency should not be less than the minimum requirements in accordance with Ecodesign regulations.

**2.2.2.3** New or replacement storage heaters should have a heat retention not less than 45 % measured according to I.S. EN 60531:2000. They should incorporate a timer and electronic room thermostat to control the heat output that are user adjustable.

**2.2.2.4** For fully pumped hot water-based central heating systems utilising a biomass independent boiler, the boiler seasonal efficiency should be not less than 77 % as specified in the DEAP manual and the associated Home-heating Appliance Register of Performance (HARP) database maintained by the SEAI ([www.seai.ie/harp](http://www.seai.ie/harp)).



---

### **2.2.3 Space heating and hot water supply system controls**

**2.2.3.1** Space and water heating systems should be effectively controlled so as to ensure the efficient use of energy by limiting the provision of heat energy use to that required to satisfy user requirements, insofar as is reasonably practicable. The aim should be to provide the following minimum level of control:

- automatic control of space heating on the basis of room temperature;
- automatic control of heat input to stored hot water on the basis of stored water temperature;
- separate and independent automatic time control of space heating and hot water; and
- shut down of boiler or other heat source when there is no demand for either space or water heating from that source.

The guidance in paragraphs 2.2.3.2 to 2.2.3.5 below is specifically applicable to fully pumped hot water-based central heating systems.

**2.2.3.2** Provision should be made to control heat input on the basis of temperature within the heated space, e.g. by the use of room thermostats, thermostatic radiator valves, or other equivalent form of sensing device. For larger dwellings, independent temperature control should generally be provided for separate zones that normally operate at different temperatures, e.g. living and sleeping zones. Thermostats should be located in a position representative of the temperature in the area being controlled and which is not unduly influenced by draughts, direct sunlight or other factors which would directly affect performance. Depending on the design and layout of the dwelling, control on the basis of a single zone will generally be satisfactory for smaller dwellings. For larger dwellings, e.g. where floor area exceeds 100

m<sup>2</sup>, independent temperature control on the basis of two independent zones will generally be appropriate. In certain cases, additional zone control may be desirable, e.g. zones which experience significant solar or other energy inputs may be controlled separately from zones not experiencing such inputs.

**2.2.3.3** Hot water storage vessels should be fitted with thermostatic control that shuts off the supply of heat when the desired storage temperature is reached.

**2.2.3.4** Separate and independent time control for space heating and for heating of stored water should be provided. Independent time control of space heating zones may be appropriate where independent temperature control applies.

**2.2.3.5** The operation of controls should be such that the boiler is switched off when no heat is required for either space or water heating, i.e. boiler interlock. Systems controlled by thermostatic radiator valves should be fitted with flow control or other equivalent device to ensure boiler switch off.

**2.2.3.6** Guidance for controls for heat pumps is provided in Tables 2 and 3.

### **2.2.4 Insulation of hot water storage vessels, pipes and ducts**

**2.2.4.1** All hot water storage vessels, pipes and ducts associated with the provision of heating and hot water in a dwelling should be insulated to prevent heat loss. Hot water pipes and ducts within the normally heated area of the dwelling that contribute to the heat requirement of the dwelling do not require insulation (except those referred to in paragraph 2.2.4.4). Pipes and ducts which are incorporated into wall, floor or roof construction should be insulated.

**2.2.4.2** Adequate insulation of hot water storage vessels can be achieved by the use of a storage vessel with factory applied insulation of such characteristics that, when tested on a 120 litre cylinder complying with

---

I.S. 161:1975 using the method specified in Annex B of BS 1566-1:2002+A1:2011, standing heat losses are restricted to 0.8 W/litre. Use of a storage vessel with 50 mm, factory applied coating of PU-foam having zero ozone depletion potential and a minimum density of 30 kg/m<sup>3</sup> satisfies this criterion. Alternative insulation measures giving equivalent performance may also be used.

**2.2.4.3** Unless the heat loss from a pipe or duct carrying hot water contributes to the useful heat requirement of a room or space, the pipe or duct should be insulated. The following levels of insulation should suffice:

- (a) pipe or duct insulation meeting the recommendations of BS 5422:2009 Methods of specifying thermal insulating materials for pipes, ductwork and equipment (in the temperature range - 40 °C to + 700 °C); or
- (b) insulation with material of such thickness that gives an equivalent reduction in heat loss as that achieved using material having a thermal conductivity at 40 °C of 0.035 W/mK and a thickness equal to the outside diameter of the pipe, for pipes up to 40 mm diameter, and a thickness of 40 mm for larger pipes.

**2.2.4.4** The hot pipes connected to hot water storage vessels, including the vent pipe and the primary flow and return to the heat exchanger, where fitted, should be insulated to the standard outlined in paragraph 2.2.4.3 above, for at least one metre from their point of connection.

**2.2.4.5** It should be noted that water pipes and storage vessels in unheated areas will generally need to be insulated for the purpose of protection against freezing. Guidance on suitable protection measures is given in Technical Guidance Document G and Report BR 262, Thermal insulation: avoiding risks, published by BRE.

## **2.3 MAJOR RENOVATION**

**2.3.1** *Major Renovation* means the renovation of a dwelling where more than 25 % of the surface of the dwelling envelope undergoes renovation.

**2.3.2** Where a dwelling undergoes major renovation, the energy performance of the whole dwelling should be improved to Cost Optimal level insofar as this is technically, functionally and economically feasible.

**2.3.3** The cost optimal level to be achieved is:

a) An energy performance of 125 kWh/m<sup>2</sup>/yr when calculated in DEAP as set out in Table 7 (Column 2)

or

b) Implementing the energy performance improvements as set out in Table 7 (Column 3) insofar as they are technically, functionally and economically feasible.

**2.3.4** In order to calculate the percentage of the surface of the dwelling envelope undergoing renovation, Table 6 describes the areas affected by works that should be included.

The surface area of the dwelling thermal envelope means the entire surface area of a dwelling through which it can lose heat to the external environment or the ground, including all heat loss areas of walls, windows, floors and roof.

Appendix F provides examples on how to calculate the percentage of renovation surface area for typical dwellings.

**2.3.5** The cost of renovation to a cost optimum level should be technically, functionally and economically feasible. Table 7 (Column 1) describes the works and elements that qualify as a Major Renovation.

**2.3.6** Where a new extension is added to an existing dwelling and affects more than 25 % of the surface area of the existing dwelling's envelope, then the final energy performance of the completed dwelling should achieve the cost optimal level.

**2.3.7** When undertaking works on, or in connection with, a building that is of architectural or historical interest or permeable traditional construction, the aim should be to improve the building as far as is reasonably practicable. The work should not prejudice the character of the building or increase the risk of long-term deterioration of the building fabric or fittings. Refer to sub-section 0.6.

**2.3.8** Where major renovation upgrades are being carried out, care should be taken to ensure compliance with the ventilation requirements of Part F and of Part J of the Building Regulations. Refer to Clause 10 of S.R. 54:2014 Code of practice for the energy efficient retrofit of dwellings.

### 2.3.9 Electric Vehicle Recharging Infrastructure

**2.3.9.1** When major renovation upgrades are being carried out to a multi-unit building ducting infrastructure, namely conduits for electric cables, should be provided for every parking space, to enable the installation of recharging points for electric vehicles where:

- the car park is located inside the building, e.g. a basement car park, and the renovation measures include the car park or the electrical infrastructure of the building; and/ or
- the car park is physically adjacent to the building, i.e. the car park is within the curtilage of the site, and the renovation measures include the car park or the electrical infrastructure of the car park.

**2.3.9.2** Where electric vehicle recharging infrastructure is provided the guidance provided in Paragraph 1.4.6.3 should be followed.

<b>Table 6</b>	
<b>Elemental works that are included in the surface area calculation for major renovation<sup>1,2,3</sup></b>	
<b>External walls renovation</b>	<ul style="list-style-type: none"> <li>• External insulation of the heat-loss walls</li> <li>• Replacement or upgrade of the external walls' structure</li> <li>• Internal lining of the surface of heat-loss walls</li> </ul>
<b>Windows renovation</b>	<ul style="list-style-type: none"> <li>• Replacement of windows</li> </ul>
<b>Roofs renovation</b>	<ul style="list-style-type: none"> <li>• Replacement of roof structure</li> </ul>
<b>Floors renovation</b>	<ul style="list-style-type: none"> <li>• Replacement of floors</li> </ul>
<b>Extension</b>	<ul style="list-style-type: none"> <li>• Extension works which affect more than 25 % of the surface area of the existing dwelling</li> </ul>
<b>Notes:</b>	
1. Major renovation requirement can be activated by works to a single element or to a combination of elements as per Table 7 (Column 1).	
2. Where major renovations to walls, roofs and ground floors constitute essential repairs e.g. repair or renewal of works due to fire, storm or flood damage or damage as a result of a material defect such as reactive pyrite in sub-floor hardcore or defective concrete blockwork, it is not considered economically feasible to bring these renovations to a cost optimal level.	
3. Painting, re-plastering, rendering, re-slating, re-tiling, cavity wall insulation and insulation of ceiling are not considered major renovation works.	

**Table 7 - Cost Optimal Works activated by Major Renovation**

Major Renovation > 25 % surface area <sup>1,2,3,5</sup>	Cost Optimal level as calculated in DEAP (Paragraph 2.3.3 a.)	Works to bring dwelling to cost optimal level in so far as they are technically, economically and functionally feasible (Paragraph 2.3.3 b.)
External walls renovation	The cost optimal performance level to be achieved is 125 kWh/m <sup>2</sup> /yr.	Upgrade insulation at ceiling level (roof) where U-values are greater than in Table 5 and Oil or gas boiler replacement <sup>6</sup> and controls upgrade where the oil or gas boiler is more than 15 years old and efficiency less than 86 % and/or Replacement of electric storage heating <sup>7</sup> systems where more than 15 years old and with heat retention not less than 45 % measured according to IS EN 60531.
External walls and windows renovation		
External walls and roof renovation		
External walls and floor renovation		
New Extension affecting more than 25 % of the surface area of the existing dwelling's envelope (see 2.3.6)	The cost optimal performance level to be achieved is 125 kWh/m <sup>2</sup> /yr	Upgrade insulation at ceiling level (roof) where U-values are greater than in Table 5 and Oil or gas boiler replacement <sup>6</sup> and controls upgrade where the oil or gas boiler is more than 15 years old and efficiency less than 86 % and/or Replacement of electric storage heating <sup>7</sup> systems where more than 15 years old and with heat retention not less than 45 % measured according to IS EN 60531 and Upgrade insulation at wall level where U-values are greater than in table 5.
Windows Renovation	Not applicable <sup>4</sup>	Not applicable <sup>4</sup>
Roof Renovation		
Floor Renovation		
Roof and windows renovation		
Windows and floor renovation		
Roof and floor renovation		

**Notes:**

1. Where works are planned as a single project.
2. Where major renovations to walls, roofs and ground floors constitute essential repairs e.g. repair or renewal of works due to fire, storm or flood damage or as a result of a material defect e.g. reactive pyrite in sub-floor hardcore, it is not considered economically feasible to bring these renovations to a cost optimal level.
3. Major Renovation of external wall elements should also meet the requirements of Table 5.
4. It is not considered technically, functionally or economically feasible to bring the whole building to cost optimal level when replacing the surface area of these elements.
5. Subject to the requirements of Table 5 for Material Alterations and window and door replacement.
6. Oil or gas boiler replacement should be with a boiler or a renewable energy source with an efficiency as given in section 2.2.2.
7. Replacement of electric storage heating should be with a heat generator with an efficiency as given in section 2.2.2.

---

# *APPENDICES*

# Appendix A

## Calculations of U-values

---

### GENERAL

**A1.1** General guidance on the calculation of U-values is contained in Report BR 443 “Conventions for the Calculation of U-values” 2006. For building elements and components generally, the method of calculating U-values is specified in I.S. EN ISO 6946:2017. U-values of components involving heat transfer to the ground, e.g. ground floors with or without floor voids, basement walls, are calculated by the method specified in I.S. EN ISO 13370:2017. A soil thermal conductivity of 2.0 W/mK should be used, unless otherwise verified. U-values for windows, doors and shutters may be calculated using I.S. EN ISO 10077-1:2017 or I.S. EN ISO 10077-2:2017. U-values for curtain walling should be calculated using I.S. EN ISO 12631:2017 or tested in accordance to I.S. EN ISO 12567-1:2010. Information on U-values and guidance on calculation procedures contained in the 8th edition of CIBSE Guide Section A3: Thermal Properties of Building Structures are based on these standards and may be used to show compliance with this Part.

A method for assessing U-values of light steel-framed constructions is given in Digest 465 “U-values for light steel construction”, published by BRE. Guidance in relation to the calculation of U-values for various forms of metal clad construction can be found in Technical Paper No. 14 “Guidance for the design of metal roofing and cladding to comply with Approved Document L2: 2001” published by MCRMA, Technical Information Sheet No. 312, “Metal cladding: U-value calculation assessing thermal performance of built-up metal roof and wall cladding systems using rail and bracket spacers” published by SCI and IP 10/02 “Metal cladding: assessing thermal performance of built-up systems which use ‘Z’ spacers” published by BRE.

Software packages to perform U-value calculations in accordance with the standards above are readily available.

**A1.2** U-values derived by calculation should be rounded to two significant figures and relevant information on input data should be provided. When calculating U-values the effects of timber joists, structural and other framing, mortar bedding, window frames and other small areas where thermal bridging occurs must be taken into account. Similarly, account must be taken of the effect of small areas where the insulation level is reduced significantly relative to the general level for the component or structure element under consideration. Thermal bridging may be disregarded, however, where the general thermal resistance does not exceed that in the bridged area by more than 0.1 m<sup>2</sup>K/W. For example, normal mortar joints need not be taken into account in calculations for brickwork or concrete blockwork where the density of the brick or block material is in excess of 1500 kg/m<sup>3</sup>. A ventilation opening in a wall or roof (other than a window, rooflight or door opening), may be considered as having the same U-value as the element in which it occurs.

**A1.3** Examples of the application of the calculation method specified in I.S. EN 6946: 2017 are given below. An example of the calculation of ground floor U-values using I.S. EN ISO 13370:2017 is also given.

**A1.4** Thermal conductivities of common building materials are given in Table A1. For the most part, these are taken from I.S. EN ISO 10456:2007 or CIBSE Guide A, Appendix 3.A7. Values for common insulation materials are also available in these documents. See paragraph 0.3.3 regarding application of these Tables.

### SIMPLE STRUCTURE WITHOUT THERMAL BRIDGING

**A2.1** To calculate the U-value of a building element (wall or roof) using I.S. EN ISO 6946:2017, the thermal resistance of each component is calculated, and these thermal resistances, together with surface resistances as appropriate, are then combined to yield the

---

total thermal resistance and U-value. The result is corrected to account for mechanical fixings (e.g. wall ties) or air gaps if required. For an element consisting of homogenous layers with no thermal bridging, the total resistance is simply the sum of individual thermal resistances and surface resistances. I.S. EN 6946:2017 provides for corrections to the calculated U-value. In the case of Example A1 (see Diagram A1), corrections for air gaps in the insulated layer and for mechanical fasteners may apply. However, if the total correction is less than 3 % of the calculated value, the correction may be ignored.

In this case no correction for air gaps applies as it is assumed that the insulation boards meet the dimensional standards set out in I.S. EN ISO 6946:2017 and that they are installed without gaps greater than 5 mm.

The construction involves the use of wall ties that penetrate fully through the insulation layer.

A potential correction factor applies which, assuming the use of 4 mm diameter stainless steel ties at 5 ties per m<sup>2</sup>, is calculated as 0.006 W/m<sup>2</sup>K. This is equal to 3 % of the calculated U-value and the corrected U-value for this structure would be 0.19 W/m<sup>2</sup>K. It should be noted that, if galvanised steel wall ties were used, a correction of 0.02 W/m<sup>2</sup>K would apply, and the corrected U-value for this construction would be 0.20 W/m<sup>2</sup>K.

**Table A1 Thermal conductivity of some common building materials**

Material	Density (kg/m <sup>3</sup> )	Thermal Conductivity (W/mK)
<b>General Building Materials</b>		
Clay brickwork (outer leaf)	1,700	0.77
Clay brickwork (inner leaf)	1,700	0.56
Concrete block (heavyweight)	2,000	1.33
Concrete block (medium weight)	1,400	0.57
Concrete block (autoclaved aerated)	700	0.20
Concrete block (autoclaved aerated)	500	0.15
Concrete block (hollow)	1800	0.835
Cast concrete, high density	2,400	2.00
Cast concrete, medium density	1,800	1.15
Aerated concrete slab	500	0.16
Concrete screed	1,200	0.41
Reinforced concrete (1 % steel)	2,300	2.30
Reinforced concrete (2 % steel)	2,400	2.50
Wall ties, stainless steel	7,900	17.00
Wall ties, galvanised steel	7,800	50.00
Mortar (protected)	1,750	0.88
Mortar (exposed)	1,750	0.94
External rendering (cement sand)	1,800	1.00
Plaster (gypsum lightweight)	600	0.18
Plaster (gypsum)	1,200	0.43
Plasterboard	900	0.25
Natural slate	2,500	2.20
Concrete tiles	2,100	1.50
Clay tiles	2,000	1.00
Fibre cement slates	1,800	0.45
Ceramic/Porcelain tiles	2,300	1.30
Plastic tiles	1,000	0.20
Asphalt	2,100	0.70
Felt bitumen layers	1,100	0.23
Timber, softwood	500	0.13
Timber, hardwood	700	0.18
Wood wool slab	500	0.10
Wood-based panels (plywood, chipboard, etc.)	500	0.13

Note:

The values in this table are indicative only. Certified values, should be used in preference, if available.



### Example A1: Masonry cavity wall

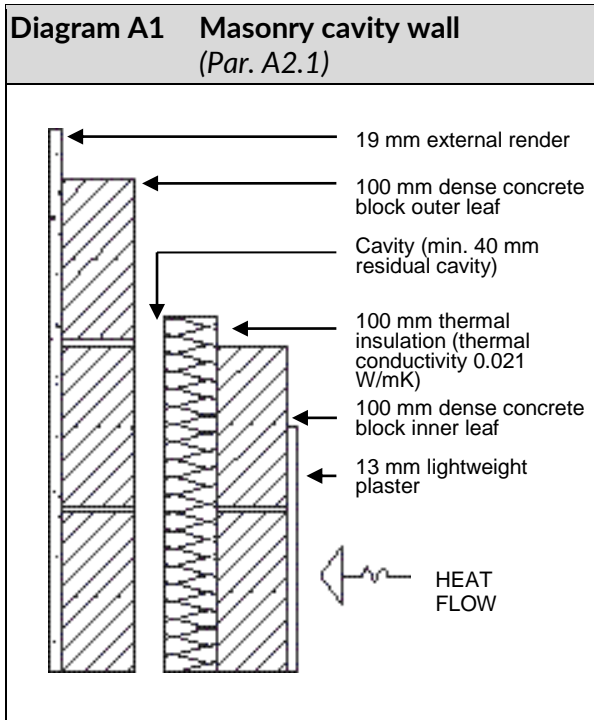

Layer/Surface	Thickness (m)	Conductivity (w/mK)	Resistance (m <sup>2</sup> K/W)
External surface	-	-	0.040
External render	0.019	1.00	0.019
Concrete block	0.100	1.33	0.075
Low-E Air cavity	0.050	-	0.440
Polyisocyanurate (PIR) Insulation	0.100	0.021	4.760
Concrete block	0.100	1.33	0.075
Plaster (lightweight)	0.013	0.18	0.072
Internal surface	-	-	0.130
Total Resistance	-	-	5.611
<b>U-value of construction = 1 / 5.611 = 0.18 W/m<sup>2</sup>K</b>			

### STRUCTURE WITH BRIDGED LAYER(S)

**A2.2** For an element in which one or more layers are thermally bridged, the total thermal resistance is calculated in three steps as follows:

- The upper thermal resistance is based on the assumption that heat flows through the component in straight lines perpendicular to the element's surfaces. To calculate it, all possible heat flow paths are identified, for each path the resistance of all layers are combined in series to give the total resistance for the path, and the resistances of all paths are then combined in parallel to give the upper resistance of the element.
- The lower thermal resistance is based on the assumption that all planes parallel to the surfaces of the component are isothermal surfaces. To calculate it, the resistances of all components of each thermally bridged layer are combined in parallel to give the effective resistance for the layer, and the resistances of all layers are then combined in series to give the lower resistance of the element.
- The total thermal resistance is the mean of the upper and lower resistances.

The percentage of timber bridging the insulation layer as a repeating thermal bridge can be calculated when the size and frequency of the timber members is known. Alternatively, the figures given in Table A2 can be used.

**Diagram A2 Timber-frame wall**  
(Par. A2.2)

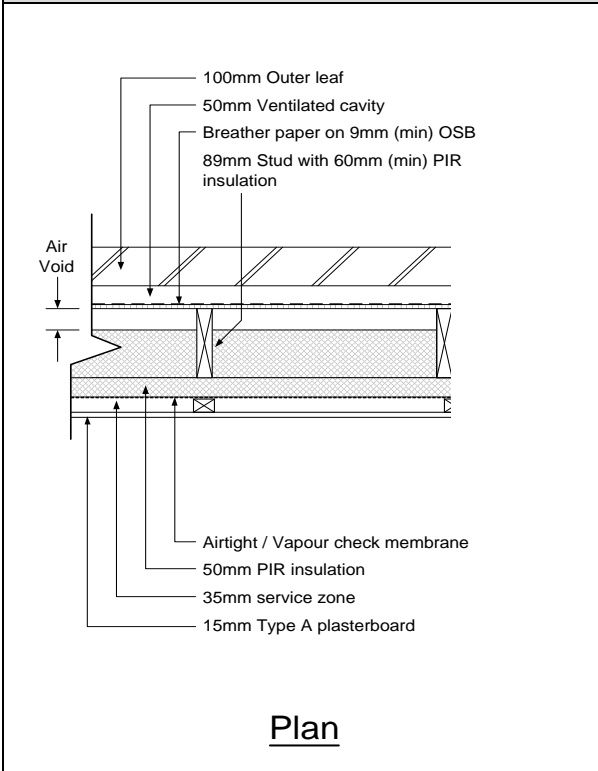

Plan

Layer/ Surface	Thickness (m)	Conductivity (W/mK)	Resistance (m <sup>2</sup> K/W)
External surface	-	-	0.040
Brick outer leaf	0.102	0.77	0.132
Air cavity	0.050	-	0.180
Breather membrane	-	-	-
Sheathing OSB	0.009	0.13	0.069
Low-E air cavity	0.029	-	0.440
Polyisocyanurate (PIR) insulation	0.060	0.021	2.857
Timber studs	0.089	0.12	0.742
Polyisocyanurate (PIR) Insulation	0.050	0.021	2.381
Vapour control layer	-	-	-
Service void	0.035	-	0.180
Timber battens	0.035	0.13	0.269
Plasterboard	0.015	0.25	0.006
Internal surface	-	-	0.130

Table A2 Timber fractions for bridged layers				
Layer	Timber frame walls	Ceiling flat/sloped	Drylined battened wall	Suspended timber floor
% Fraction	15	9	8	12

The thermal resistance of each component is calculated (or, in the case of surface resistances, entered) as follows:

### Upper resistance

Assuming that heat flows in straight lines perpendicular to the wall surfaces, there are four heat flow paths:

- Path 1: through the internal timber battens and through the timber studs;
- Path 2: through the internal timber battens and through insulation between the studs;
- Path 3: not through the internal timber battens and through the timber studs;
- Path 4: not through the internal timber battens and through the insulation between the timber studs.

The resistance of each of these paths is calculated as follows:

Resistance through path 1 [m<sup>2</sup>K/W]:

External surface resistance	0.040
Brick outer leaf	0.132
Air cavity	0.180
Sheathing ply	0.069
Timber studs	0.742
Insulation over studs	2.381
Timber battens	0.269
Plasterboard	0.006
Internal surface resistance	0.130

**Total R<sub>1</sub>** **3.949**

Fraction of path 1:  $F_1 = 0.12 \times 0.15 = 1.8 \%$

Resistance through path 2 [m<sup>2</sup>K/W]:

External surface resistance	0.040
Brick outer leaf	0.132
Air cavity	0.180
Sheathing ply	0.069
Low-E air cavity	0.440

Insulation between studs	2.857
Insulation over studs	2.381
Timber battens	0.269
Plasterboard	0.006
Internal surface resistance	0.130

**Total R<sub>2</sub> 6.504**

Fraction of path 2:  $F_2 = 0.12 \times 0.85 = 10.2 \%$

Resistance through path 3 [m<sup>2</sup>K/W]:

External surface resistance	0.040
Brick outer leaf	0.132
Air cavity	0.180
Sheathing ply	0.069
Timber studs	0.742
Insulation over studs	2.381
Air cavity	0.180
Plasterboard	0.006
Internal surface resistance	0.130

**Total R<sub>3</sub> 3.860**

Fraction of path 3:  $F_3 = 0.88 \times 0.15 = 13.2 \%$

Resistance through path 4 [m<sup>2</sup>K/W]:

External surface resistance	0.040
Brick outer leaf	0.132
Air cavity	0.180
Sheathing ply	0.069
Low-E air cavity	0.440
Insulation between studs	2.857
Insulation over studs	2.381
Air cavity	0.180
Plasterboard	0.006
Internal surface resistance	0.130

**Total R<sub>4</sub> 6.415**

Fraction of path 4:  $F_4 = 0.88 \times 0.85 = 74.8 \%$

The upper thermal resistance R<sub>u</sub> is obtained from:

$$R_u = 1 / (F_1 / R_1 + F_2 / R_2 + F_3 / R_3 + F_4 / R_4)$$

where F<sub>1</sub>, F<sub>2</sub>, F<sub>3</sub> and F<sub>4</sub> are the fractional areas of heat flow paths 1, 2, 3 and 4 and R<sub>1</sub>, R<sub>2</sub>, R<sub>3</sub>

and R<sub>4</sub> are the resistances of these paths.

$$\text{Upper resistance } R_u = 1 / (0.018 / 3.949 + 0.102 / 6.504 + 0.132 / 3.860 + 0.748 / 6.415) = 5.847 \text{ m}^2\text{K/W}$$

### Lower resistance

Assuming an isothermal plane on each face of the layer of insulation which is bridged by timber studs, the thermal resistance of this bridged layer, R<sub>b</sub>, is calculated from:

$$R_b = 1 / (F_{ins} / R_{ins} + F_t / R_t)$$

where F<sub>ins</sub> and F<sub>t</sub> are the fractional areas of insulation and timber, and R<sub>ins</sub> and R<sub>t</sub> are their resistances.

$$R_b = 1 / (0.85 / 2.857 + 0.15 / 0.742) = 2.001 \text{ m}^2\text{K/W}$$

Assuming an isothermal plane on each face of the service void layer which is bridged by timber battens, the thermal resistance of this bridged layer, R<sub>sc</sub>, is calculated from:

$$R_{sc} = 1 / (F_{al} / R_{al} + F_{tb} / R_{tb})$$

where F<sub>al</sub> and F<sub>tb</sub> are the fractional areas of air layer and timber battens, and R<sub>al</sub> and R<sub>tb</sub> are their resistances.

$$R_{sc} = 1 / (0.88 / 0.18 + 0.12 / 0.269) = 0.187 \text{ m}^2\text{K/W}$$

The resistances of all layers are then combined in series to give the lower resistance [m<sup>2</sup>K/W]:

External surface resistance	0.040
Brick outer leaf	0.132
Air cavity	0.180
Sheathing Ply	0.069
Bridged insulation layer	2.001
Insulation over studs	2.381
Bridged service void	0.187
Plasterboard	0.006
Internal surface resistance	0.130

Lower resistance ( $R_L$ )

5.126

### Total resistance

The total resistance  $R_t$  is given by:

$$R_t = (R_u + R_L) / 2 = (5.847 + 5.126) / 2 = 5.487 \text{ m}^2\text{K/W}$$

The U-value is the reciprocal of the total resistance:

$$U\text{-value} = 1 / 5.487 = 0.18 \text{ W/m}^2\text{K (to 2 decimal places)}$$

There is a potential correction for air gaps in the insulation layer. In this case no correction for air gaps applies as it is assumed that the insulation boards are factory fitted and meet the dimensional standards set out in I.S. EN ISO 6946:2017 and that they are installed without gaps greater than 5 mm.

### Example A3: Domestic pitched roof with insulation at ceiling level (between and over joists)

A pitched roof has 100 mm of mineral wool tightly fitted between 44 mm by 100 mm timber joists spaced 600 mm apart (centres to centres) and 150 mm of mineral wool over the joists. The roof is slated or tiled with sarking felt under the slates or tiles. The ceiling consists of 13 mm of plasterboard. The fractional area of timber at ceiling level is taken as 9 %.

**Diagram A3 Domestic pitched roof (Par. A2.2)**

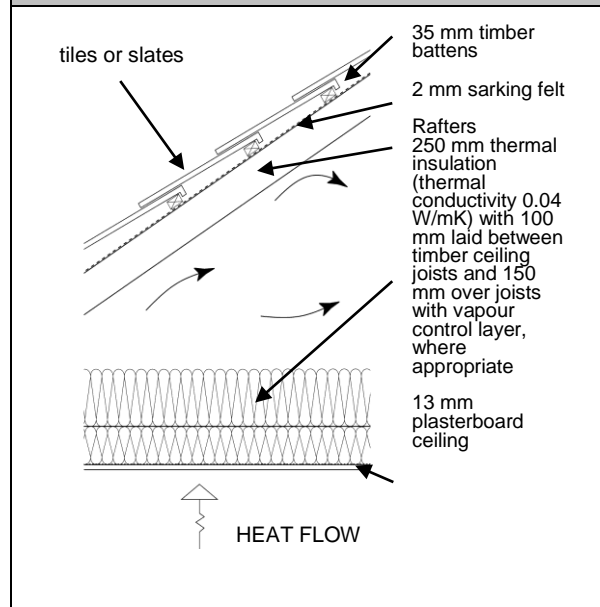

Layer/Surface	Thickness (m)	Conductivity (W/mK)	Resistance (m <sup>2</sup> K/W)
External surface	-	-	0.040
Roof space (including sloping construction and roof cavity)	-	-	0.200
Mineral wool (continuous layer)	-	-	0.200
Mineral wool (between joists)	0.150	0.04	3.750
Timber joists	0.100	0.04	2.500
Plasterboard	0.100	0.13	0.769
Internal surface	0.013	0.25	0.052
	-	-	0.100

### Upper resistance ( $R_u$ )

Resistance through section containing both layers of insulation [m<sup>2</sup>K/W]:

External surface resistance	0.040
Resistance of roof space	0.200
Resistance of mineral wool over joists	3.750
Resistance of mineral wool between joists	2.500
Resistance of plasterboard	0.052
Inside surface resistance	0.100

**Total** **6.642**

Resistance through section containing timber

---

joists:	
External surface resistance	0.040
Resistance of roof space	0.200
Resistance of mineral wool over joists	3.750
Resistance of timber joists	0.769
Resistance of plasterboard	0.052
Inside surface resistance	0.100

**Total** **4.911**

The upper thermal resistance [ $R_u$ ] is obtained from:

$$R_u = 1 / (F_1 / R_1 + F_2 / R_2)$$

where  $F_1$  and  $F_2$  are the fractional areas of heat flow paths 1 and 2, and  $R_1$  and  $R_2$  are the resistances of these paths.

$$\text{Upper resistance } R_u = 1 / (0.91 / 6.642 + 0.09 / 4.911) = 6.438 \text{ m}^2\text{K/W}$$

#### Lower resistance ( $R_L$ )

Assuming an isothermal plane on each face of the layer of insulation which is bridged by timber studs, the thermal resistance of this bridged layer,  $R_b$ , is calculated from:

$$R_b = 1 / (F_{ins} / R_{ins} + F_t / R_t)$$

where  $F_{ins}$  and  $F_t$  are the fractional areas of insulation and timber, and  $R_{ins}$  and  $R_t$  are their resistances.

$$R_b = 1 / (0.91 / 2.500 + 0.09 / 0.769) = 2.079 \text{ m}^2\text{K/W}$$

The resistances of all layers are then combined in series to give the lower resistance [ $\text{m}^2\text{K/W}$ ]:

External surface resistance	0.040
Resistance of roof space	0.200
Resistance of mineral wool over joists	3.750
Resistance of bridged layer	2.079
Resistance of plasterboard	0.052
Inside surface resistance	0.100

#### Lower resistance ( $R_L$ )

**6.221**

#### Total resistance

The total resistance  $R_t$  is given by:

$$R_t = (R_u + R_L) / 2 = (6.438 + 6.221) / 2 = 6.329 \text{ m}^2\text{K/W}$$

The U-value is the reciprocal of the total resistance: -

$$\text{U-value} = 1 / 6.329 = 0.16 \text{ W/m}^2\text{K (to 2 decimal places).}$$

I.S. EN ISO 6946:2017 does not specify any potential correction for this construction.

### GROUND FLOORS AND BASEMENTS

**A3.1** The U-value of an uninsulated ground floor depends on a number of factors including floor shape and area and the nature of the soil beneath the floor. I.S. EN ISO 13370:2017 deals with the calculation of U-values of ground floors. Methods are specified for floors directly on the ground and for floors with vented and unvented sub-floor spaces. I.S. EN ISO 13370:2017 also covers heat loss from basement floors and walls.

**A3.2** In the case of semi-detached or terraced premises, blocks of flats and similar buildings, the floor dimensions can be taken as either those of the individual premises or those of the whole building. Unheated spaces outside the insulated fabric, such as attached porches or garages, should be excluded when deriving floor dimensions but the length of the floor perimeter between the heated building and the unheated space should be included when determining the length of exposed perimeter. Where such ancillary areas have the potential to become part of the habitable area of the dwelling, floors should be insulated to the same level as the dwelling floors unless it is envisaged that a new insulated floor will be provided when converted.

### Example A4: Slab-on-ground floor – full floor insulation

The slab-on-ground floor consists of a 150 mm dense concrete ground floor slab on 100 mm insulation.

**Diagram A4 Concrete slab-on-ground floor (Par. A3.1)**

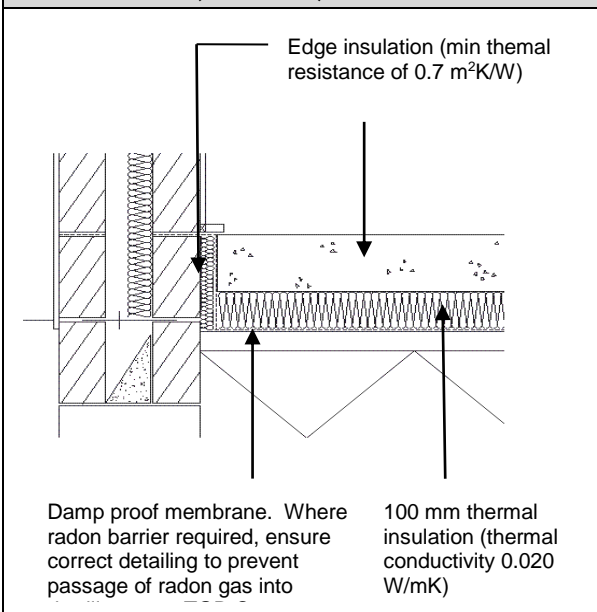

The insulation has a thermal conductivity of 0.020 W/mK. The floor dimensions are 8750 mm by 7250 mm with three sides exposed. One 8750 mm side abuts the floor of an adjoining semi-detached house.

In accordance with I.S. EN ISO 13370:2017, the following expression gives the U-value for well-insulated floors:

$$U = \lambda / (0.457B' + d_t), \text{ where:}$$

$\lambda$  = thermal conductivity of unfrozen ground (W/mK)  
 $B'$  =  $2A/P$  (m)  
 $d_t$  =  $w + \lambda(R_{si} + R_f + R_{se})$  (m)  
 $A$  = floor area (m<sup>2</sup>)  
 $P$  = heat loss perimeter (m)  
 $w$  = wall thickness (m)

$R_{si}$ ,  $R_f$  and  $R_{se}$  are internal surface resistance, floor construction (including insulation) resistance and external surface resistance respectively. Standard values of  $R_{si}$  and  $R_{se}$  for floors are given as 0.17 m<sup>2</sup>K/W and 0.04 m<sup>2</sup>K/W respectively. The standard also states that the thermal resistance of dense concrete slabs and thin floor coverings may be ignored in the calculation and that the thermal conductivity of the ground should be taken as 2.0 W/mK unless otherwise known or specified.

Ignoring the thermal resistance of the dense concrete slab, the thermal resistance of the floor construction ( $R_f$ ) is equal to the thermal resistance of the insulation alone, i.e.  $0.1 / 0.020$  or 5.00 m<sup>2</sup>K/W. Taking the wall thickness as 350 mm, this gives:

$$d_t = 0.35 + 2.0 \cdot (0.17 + 5.00 + 0.04) = 10.77 \text{ m}$$

$$\text{Also } B' = \frac{2(8.75 \times 7.25)}{(8.75 + 7.25 + 7.25)} = 5.457 \text{ m}$$

$$\text{Therefore } U = \frac{2.0}{((0.457 \times 5.457) + 10.77)} = 0.15 \text{ W/m}^2\text{K}$$

The edge insulation to the slab is provided to prevent thermal bridging at the edge of the slab. I.S. EN ISO 13370:2017 does not consider this edge insulation as contributing to the overall floor insulation and thus reducing the floor U-value. However, edge insulation, which extends below the external ground level, is considered to contribute to a reduction in floor U-value and a method of taking this into account is included in the standard. Foundation walls of insulating lightweight concrete may be taken as edge insulation for this purpose.

### ELEMENTS ADJACENT TO UNHEATED SPACES

**A4.1** As indicated in paragraph 0.3.5, the procedure for the calculation of U-values of elements adjacent to unheated spaces (previously referred to as semi-exposed

---

elements) is given in I.S. EN ISO 6946:2017 and I.S. EN ISO 13789:2017.

The following formulae may be used to derive elemental U-values (taking the unheated space into account) for typical housing situations irrespective of the precise dimensions of the unheated space.

$$U_o = 1 / (1/U - R_u) \text{ or } U = 1 / (1/U_o + R_u)$$

- Where: U     -   U-value of element adjacent to unheated space (W/m<sup>2</sup>K), taking the effect of the unheated space into account.
- U<sub>o</sub>     -   U-value of the element between heated and unheated spaces (W/m<sup>2</sup>K) calculated as if there was no unheated space adjacent to the element.
- R<sub>u</sub>     -   Effective thermal resistance of unheated space inclusive of all external elements (m<sup>2</sup>K/W).

This procedure can be used when the precise details on the structure providing an unheated space are not available, or not crucial.

R<sub>u</sub> for typical unheated structures (including garages, access corridors to flats and unheated conservatories) are given in Tables A3, A4 and A5.

Table A5 applies only where a conservatory-style sunroom is not treated as an integral part of the dwelling, i.e. is treated as an extension.

In the case of room-in-roof construction, the U-value of the walls of the room-in-roof construction and of the ceiling of the room below the space adjacent to these walls can

be calculated using this procedure. See Diagram A5.

Alternatively R<sub>u</sub> can be calculated using the following formula as detailed in BRE 443, to represent more accurately the resistance through the fabric and unheated space e.g. in apartment walls facing unheated corridors:

$$R_u = \frac{A_i}{\sum(A_e \times U_e) + 0.33nV}$$

A<sub>i</sub> and A<sub>e</sub> are the respective areas of internal and external elements (m<sup>2</sup>), excluding any ground floor;

U<sub>e</sub> = U-values of external elements (W/m<sup>2</sup>K)

V = volume of unheated space (m<sup>3</sup>)

n = air change rate of unheated space (ach) (see Table A6)

The DEAP Methodology provides a software tool for this formula.

**Table A3 Typical resistance ( $R_u$ ) for unheated space**

**(a) Integral and adjacent single garages or other similar unheated space**

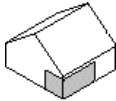
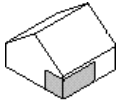
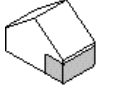
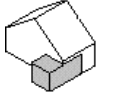
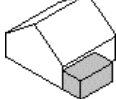
Garage or other similar unheated space		Element between garage and dwelling	$R_u$	
			Outside <sup>1</sup>	Inside <sup>2</sup>
Single fully integral		Side wall, end wall and floor	0.33	0.68
Single fully integral		One wall and floor	0.25	0.54
Single, partially integral displaced forward		Side wall, end wall and floor	0.26	0.56
Single, adjacent		One wall	0.09	

**Notes:**

The table gives  $R_u$  for single garages; use  $(0.5 \times R_u)$  for double garages when extra garage is not fully integral, and  $(0.85 \times R_u)$  for fully integral double garages. Single garage means a garage for one car; double garage means a garage for two cars.

1. Walls separating garage from dwelling are external walls.
2. Insulated envelope of dwelling goes round outside of garage.



Table A4 Typical resistance ( $R_u$ ) for unheated space	
(b) Unheated stairwells and access corridors in flats	
Unheated space	$R_u$
Stairwells:	
Facing wall exposed	0.82
Facing wall not exposed	0.90
Access corridors:	
Facing wall exposed, corridor above or below	0.31
Facing wall exposed, corridor above and below	0.28
Facing wall not exposed, corridor above or below	0.43
Facing wall not exposed, corridor above and below	0.40

Table A5 Typical resistance ( $R_u$ ) for unheated space	
(c) Conservatory-type sunroom	
Number of walls between dwelling and conservatory/sunroom	$R_u$
One	0.06
Two (conservatory in angle of dwelling)	0.14
Three (conservatory in recess)	0.25

Table A6 Typical air change rates for unheated spaces (from BRE 443)	
Air tightness type	$n$ (air changes per hour)
No doors or windows, all joints between components well-sealed, no ventilation openings provided	0.1
All joints between components well-sealed, no ventilation openings provided	0.5
All joints well-sealed, small openings provided for ventilation	1.0
Not airtight due to some localised open joints or permanent ventilation openings	3.0
Not airtight due to numerous open joints, or large or numerous permanent ventilation openings	10.0

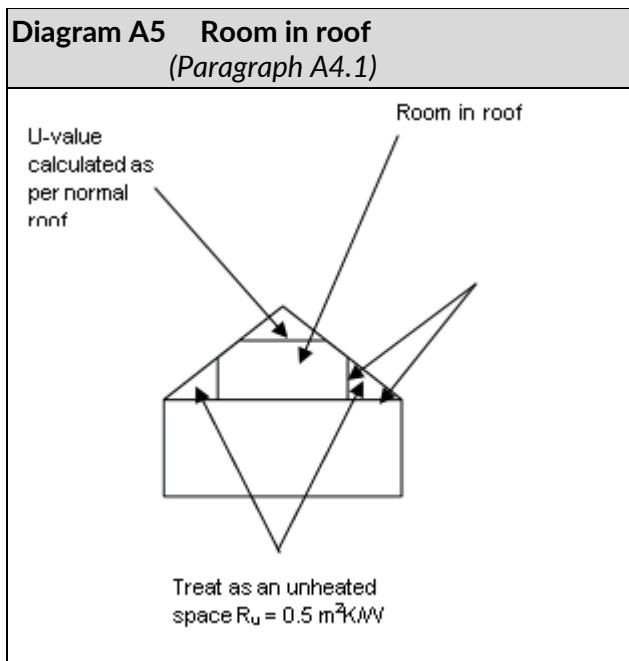

# Appendix B

## Fabric Insulation:

### Additional guidance for common constructions

---

#### GENERAL

**B.1** This Appendix provides some basic guidance in relation to typical roof, wall and floor constructions. Guidance is not exhaustive and designers and contractors should also have regard to other sources of relevant guidance, e.g. “BR 262: 2001 Thermal Insulation; avoiding risks”, relevant standards and good building practice.

In particular, diagrams in this Appendix are intended to be illustrative of the construction to which they refer. They do not purport to provide detailed guidance on the avoidance of thermal bridging. See sections 1.3.3, 2.1.3 and Limiting Thermal Bridging and Air Infiltration - Acceptable Construction Details (ACDs) for guidance on reasonable provision in this regard.

**B.2** For many typical roof, wall and floor constructions, the thickness of insulation required to achieve a particular U-value can vary depending on the thermal performance of the insulation material. Higher performing insulating materials, i.e. those with lower thermal conductivities, can achieve any given U-value with a lower thickness of insulating material.

**B.3** Condensation in buildings occurs whenever warm moist air meets surfaces that are at or below the dew point of that air. There are two main types: surface condensation and interstitial condensation.

Surface condensation occurs on the surface of walls, windows, ceilings and floors and may result in mould and mildew.

Interstitial condensation occurs within the construction of the building and can damage structural materials or make insulating materials less effective.

Full checks should be performed on the likelihood of surface and interstitial condensation of a construction detail in accordance with I.S. EN ISO 13788:2012.

This standard contains recommended procedures for the assessment of the risk of:

- surface condensation and mould growth;
- interstitial condensation.

The guidance in BRE document BR 497 Conventions for calculating linear thermal transmittance and temperature factors (2<sup>nd</sup> Edition) may be used to perform the checks in I.S. EN ISO 13788:2012.

I.S. EN 15026:2007 can also be used to assess the risk of surface and interstitial condensation and mould growth. The transient models covered in this standard take account of heat and moisture storage, latent heat effects, and liquid and convective transport under realistic boundary and initial conditions.

**B.4** A vapour control layer (VCL) substantially reduces the water vapour transfer through any building component in which it is incorporated by limiting both vapour diffusion and air movement. The measures required to achieve a functional VCL must be carefully considered at the design stage.

A VCL should extend over the whole of the element into which it is incorporated and must be integrated with and sealed to adjoining elements, such as masonry, upstands and glazing systems and to any VCL in those elements. VCLs may be formed with a membrane within the structure or with a lining board with an integral membrane. A VCL should be of appropriate vapour resistance and should be situated on the warm side of the insulation.

The performance of a VCL depends upon the vapour resistance of the material selected, the practicability of the design and the standard of workmanship involved in its installation. The integrity of the VCL should be ensured by effective sealing of all service penetrations, e.g. electrical wiring. Methods of avoiding such penetrations should be considered in the

design stage.

Side and end joints in a flexible sheet VCL should be kept to a minimum. Joints should be made over a solid backing member or substrate, lapped not less than 50 mm and sealed with an appropriate sealant. Similarly, tears and splits should be repaired using the same material, jointed as above. If polyethylene sheeting is used, it should be protected from heat and sunlight to reduce the risk of degradation occurring. Where a VCL is incorporated in a rigid board, joints between adjacent boards should be sealed to avoid mass transfer of water vapour due to air leakage. These seals should be designed to accommodate thermal or other movement which may occur during the design life of the building.

A VCL can also act as an air leakage barrier, which by reducing air movement has the added benefit of reducing the heat lost by convection.

Construction elements should be allowed sufficient time to dry in order to avoid trapped moisture prior to the installation of a VCL or internal insulation layer.

## B.5 ROOF CONSTRUCTIONS

### B.5.1 Construction R1: Tiled or slated pitched roof, ventilated roof space, insulation at ceiling level

#### B.5.1.1 R1(a) Insulation between and over joists

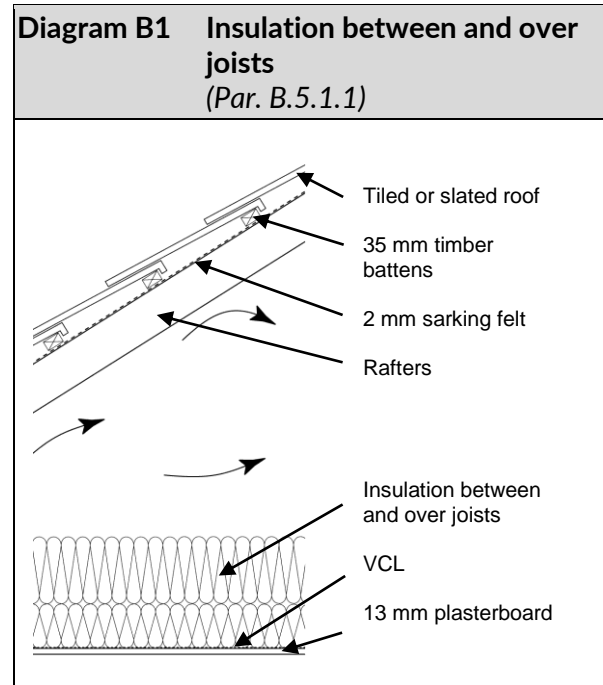

#### Installation guidelines and precautions

Care is required in design and construction, particularly in regard to the following:

##### **Provision of adequate roofspace ventilation**

Adequate ventilation is particularly important to ensure the prevention of excessive condensation in cold attic areas. See relevant guidance in Technical Guidance Document F.

##### **Minimising transfer of water vapour from occupied dwelling area to cold attic space**

In addition to ensuring adequate ventilation, measures should be taken to limit transfer of water vapour to the cold attic. Care should be taken to seal around all penetrations of pipes, ducts, wiring, etc. through the ceiling, including provision of an effective seal to the attic access hatch. Use of a VCL at ceiling level, on the warm side of the insulation, will assist in limiting vapour transfer and should therefore be used, but cannot be relied on as an alternative to ventilation. Where the roof pitch is less than 15°, or where the shape of the roof is such that there is difficulty in

ensuring adequate ventilation, e.g. room-in-the-roof construction, the VCL is essential.

### **Minimising the extent of cold bridging**

Particular areas of potential cold bridging include junctions with external walls at eaves and gables, and junctions with solid party walls. Gaps in the insulation should be avoided and the insulation should fit tightly against joists, noggings, bracing etc. Insulation joints should be closely butted and joints in upper and lower layers of insulation should be staggered (see Acceptable Construction Details, details G01 - G04).

### **Protecting water tanks and pipework against the risk of freezing**

All pipework on the cold side of the insulation should be adequately insulated. Where the cold water cistern is located in the attic, as is normally the case, the top and sides of the cistern should be insulated. The area underneath the cistern should be left uninsulated and continuity of tank and ceiling insulation should be ensured, e.g. by overlapping the tank and ceiling insulation. Provision should be made to ensure ventilation of the tank. Where raised tanks are used, (to aid head pressure), the ceiling should be insulated normally and the tank insulated separately.

### **Ensuring that there is no danger from overheating of electric cables or fittings**

Cables should be installed above the insulation. Cables which pass through or are enclosed in insulation should be adequately rated to ensure that they do not overheat. Recessed fittings and transformers should have adequate ventilation or other means to prevent overheating.

### **Providing for access to tanks, services and fittings in the roofspace**

Because the depth of insulation will obscure the location of ceiling joists, provision should be made for access from the access hatch to the cold water tank and to other fittings to which access for occasional maintenance and servicing may be required. This can be done

by provision of walkways without compressing the installed insulation or by the use of high density insulation under the walkway or by installing composite attic boards.

### **B.5.1.2 R1(b) Insulation between and below joists**

Insulation is laid in one layer between the joists, protruding above them where its depth is greater, and leaving air gaps above the joists. A composite board of plasterboard with insulation backing is used for the ceiling.

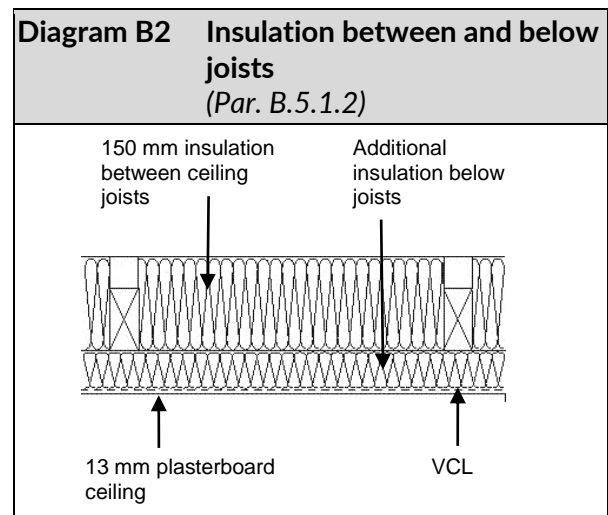

### **Installation guidelines and precautions**

Similar guidelines and precautions apply as for R1(a) above. Where the thermal conductivity of insulation between and below the joists is different, the material on the warm side (i.e. below the joists) should have a vapour resistance no lower than that on the cold side (i.e. between the joists). It is preferable if the insulation on the cold side is more permeable than that on the warm side (e.g. mineral wool outside with expanded polystyrene inside).

### **B.5.2 Construction R2: Tiled or slated pitched roof, occupied or unventilated roof space, insulation on roof slope**

**B.5.2.1 R2(a) Insulation between and below rafters, 50 mm ventilated cavity between insulation and breathable membrane**

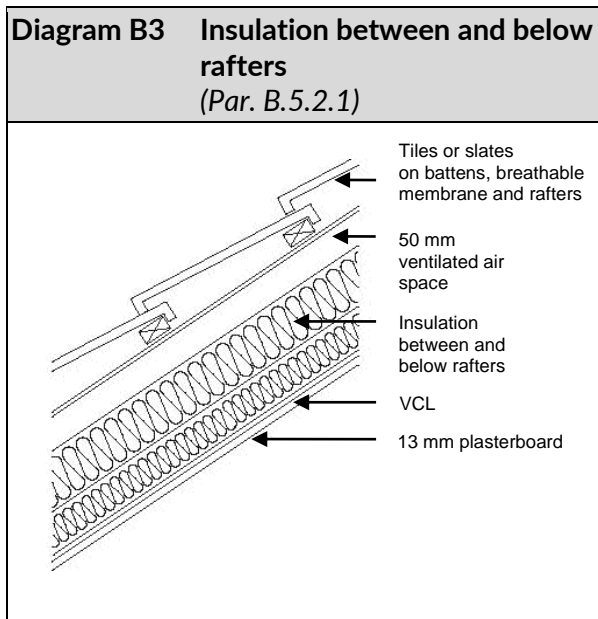

**Installation guidelines and precautions**

The insulation is installed in two layers, one between the rafters (and battens) and the second below and across them. To limit water vapour transfer and minimise condensation risks, a VCL is required on the warm side of the insulation. No material of high vapour resistance, e.g. facing layer attached to insulation to facilitate fixing, should be included within the overall thickness of insulation. Care must be taken to prevent roof timbers and access problems interfering with the continuity of insulation and VCL.

Provision should be made for ventilation top and bottom of the 50 mm ventilation gap on the cold side of the insulation.

An alternative construction using a breathable membrane may be used. In this case the membrane should be certified in accordance with Part D of the Building Regulations and installed in accordance with the guidance on the certificate.

Care should be taken to avoid thermal bridging at roof/wall junctions at eaves, gable walls and party walls (see Acceptable Construction Details, details 1.13 and 1.16).

Where the thermal conductivity of insulation between and below the rafters is different, the material on the warm side (i.e. below the rafters) should have a vapour resistance no lower than that on the cold side (i.e. between the rafters). It is preferable if the insulation on the cold side is more permeable than that on the warm side (e.g. mineral wool outside with expanded polystyrene inside).

Where walls are installed in attics for room in roof constructions the U-value for the wall should meet Table 1 provisions and be accounted for in the DEAP calculation.

Access hatches and doors to the ventilated attic void should be sealed and insulated.

**B.5.2.2 R2(b): Insulation above and between rafters, slate or tile underlay of breathable membrane type**

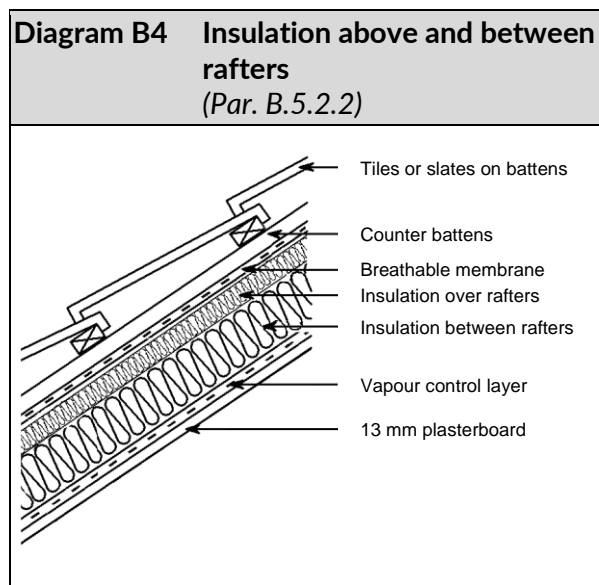

**Installation guidelines and precautions**

The effective performance of this system is critically dependent on the prevention of air

and water vapour movement between the warm and cold sides of the insulation. Only systems which are certified or shown by test and calculation as appropriate for this function, (see Technical Guidance Document D, paragraphs 1.1 (a) and (b)) should be used. The precise details of construction are dependent on the insulation and roof underlay materials to be used. Installation should be carried out precisely in accordance with the procedures described in the relevant certificate.

In general, the insulation material must be of low vapour permeability, there should be a tight fit between adjacent insulation boards, and between insulation boards and rafters. All gaps in the insulation (e.g. at eaves, ridge, gable ends, around rooflights and chimneys, etc.) should be sealed with flexible sealant or expanding foam.

Care should be taken to avoid thermal bridging at roof/wall junctions at eaves, gablewalls and party walls (see Acceptable Construction Details, details 1.14 and 1.18).

Where walls are installed in attics for room in roof constructions, the U-value for the wall should meet Table 1 provisions and be accounted for in the DEAP calculation.

Access hatches and doors to the ventilated attic void should be sealed and insulated.

### **B.5.3 Construction R3: Flat roof, timber joists, insulation below deck (Cold Deck)**

### **B.5.3 R3: Insulation between and below joists, 50 mm air gap between insulation and roof decking**

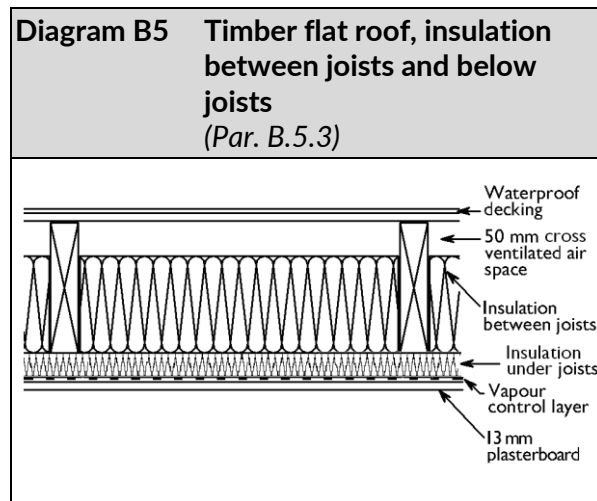

#### **Installation guidelines and precautions**

The insulation is installed in two layers, one between the joists, and the second below the joists. A ventilated air space as specified in Technical Guidance Document F should be provided above the insulation. Cross ventilation should be provided to each and every void. When installing the insulation, care is needed to ensure that it does not block the ventilation flow paths. The roof insulation should connect with the wall insulation so as to avoid a cold bridge at this point.

The lower layer may be in the form of composite boards of plasterboard backed with insulation, with integral vapour barrier, fixed to the joists. The edges of boards should be sealed with vapour-resistant tape. Where the thermal conductivity of insulation between and below the joists is different, the material on the warm side (i.e. below the joists) should have a vapour resistance no lower than that on the cold side (i.e. between the joists). It is preferable if the insulation on the cold side is more permeable than that on the warm side (e.g. mineral wool outside with expanded polystyrene inside).

**B.5.4 Construction R4: Sandwich warm deck flat roof**

The insulation is installed above the roof deck but below the weatherproof membrane. The structural deck may be of timber, concrete or metal.

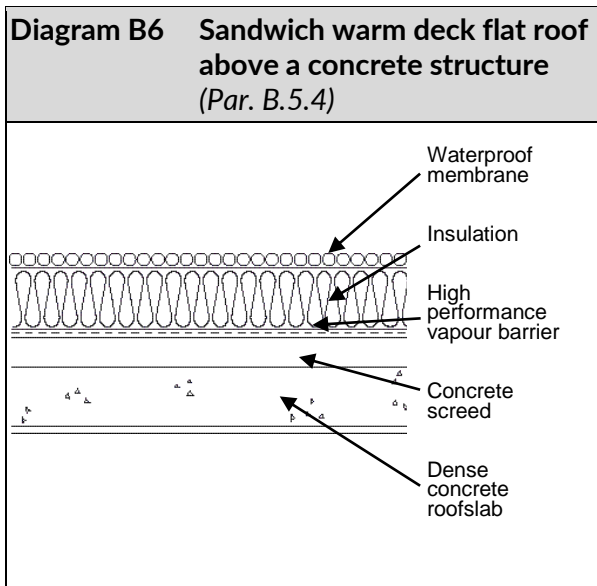

**Installation guidelines and precautions**

The insulation boards are laid over and normally fully bonded to a high performance vapour barrier complying with I.S. EN 13707: 2013 which is bonded to the roof deck. The insulation is overlaid with a waterproof membrane, which may consist of a single layer membrane, a fully-bonded built-up bitumen roofing system, or mastic asphalt on an isolating layer. At the perimeter, the vapour barrier is turned up and back over the insulation and bonded to it and the weatherproof membrane. Extreme care is required to ensure that moisture can not penetrate the vapour barrier. The insulation should not be allowed to get wet during installation. There should be no insulation below the deck nor should this area be ventilated as this could give rise to a risk of condensation on the underside of the vapour barrier. Thermal bridging at roof/wall junctions should be avoided (see Acceptable Construction Details, details 1.19 and 1.20).

**B.5.5 Construction R5: Inverted warm deck flat roof: insulation to falls above both roof deck and weatherproof membrane**

Insulation materials should have low water absorption, be frost resistant and should maintain performance in damp conditions over the long term. To balance loss of performance due to the damp conditions and the intermittent cooling effect of water passing through and draining off from the warm side of the insulation, the extra heat loss should be calculated in accordance with Clause F.4 of Annex D in I.S. EN ISO 6946:2017.

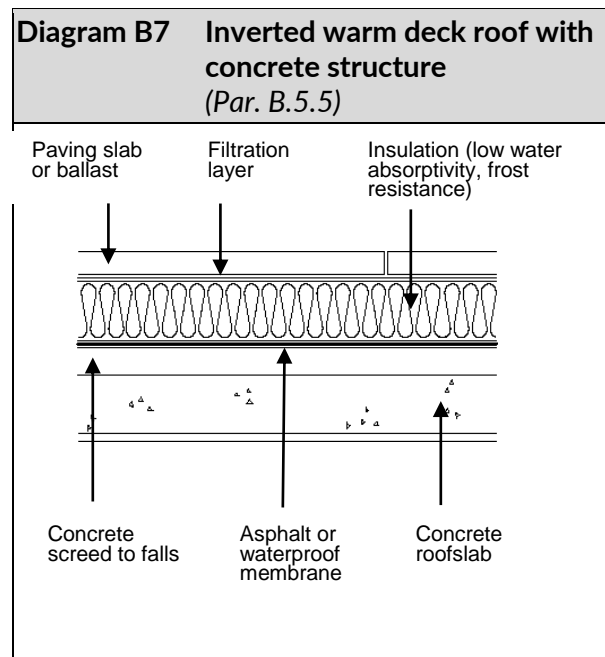

**Installation guidelines and precautions**

The insulation is laid on the waterproof membrane. A filtration layer is used to keep out grit, which could eventually damage the weatherproof membrane. The insulation must be restrained to prevent wind uplift and protected against ultraviolet degradation. This is usually achieved by use of gravel ballast, paving stones or equivalent restraint and protection. The insulation should have sufficient compressive strength to withstand the weight of the ballast and any other loads.

Rainwater will penetrate the insulation as far as the waterproof membrane. Drainage should be provided to remove this rainwater both at the upper surface and at the membrane level where practicable. To minimise the effect of rain on performance, insulation boards should be tightly jointed (rebated or tongued-and-grooved edges are preferred), and trimmed to give a close fit around upstands and service penetrations.

To avoid condensation problems, the thermal resistance of the construction between the weatherproof membrane and the heated space should be at least  $0.15 \text{ m}^2\text{K/W}$ . However, this thermal resistance should not exceed 25 % of the thermal resistance of the whole construction.

Thermal bridging at roof/wall junctions should be avoided.

## B.6 WALL CONSTRUCTIONS

### B.6.1 W1: Cavity walls, insulation in cavity, cavity retained (partial fill)

#### B.6.1.1 W1(a): Brick or rendered dense concrete block external leaf, partial fill insulation, dense concrete block inner leaf, plaster or plasterboard internal finish.

Masonry walls should comply with the relevant requirements of Eurocode 6 - Design of Masonry Structures (series) and the additional guidance given in S.R. 325:2013 Recommendations for the design of masonry structures in Ireland to Eurocode 6 (+A1:2014/ A2:2018). It should be noted that the details below refer to cavity walls with a maximum overall cavity width of 150 mm. Where cavity widths are greater than 150 mm, specialist design of wall ties is required and manufacturer's guidance should be sought.

The insulation thickness required to achieve a given U-value may be reduced by using lightweight concrete insulating blocks for the

inner leaf. When calculating the U-value in accordance with Appendix A, the inner leaf is considered a bridged layer due to the mortar with a 7 % fractional area.

Due to the sound attenuation properties of lightweight blocks their suitability for use in the inner leaves adjoining party walls may be limited when flanking sound transmission is considered.

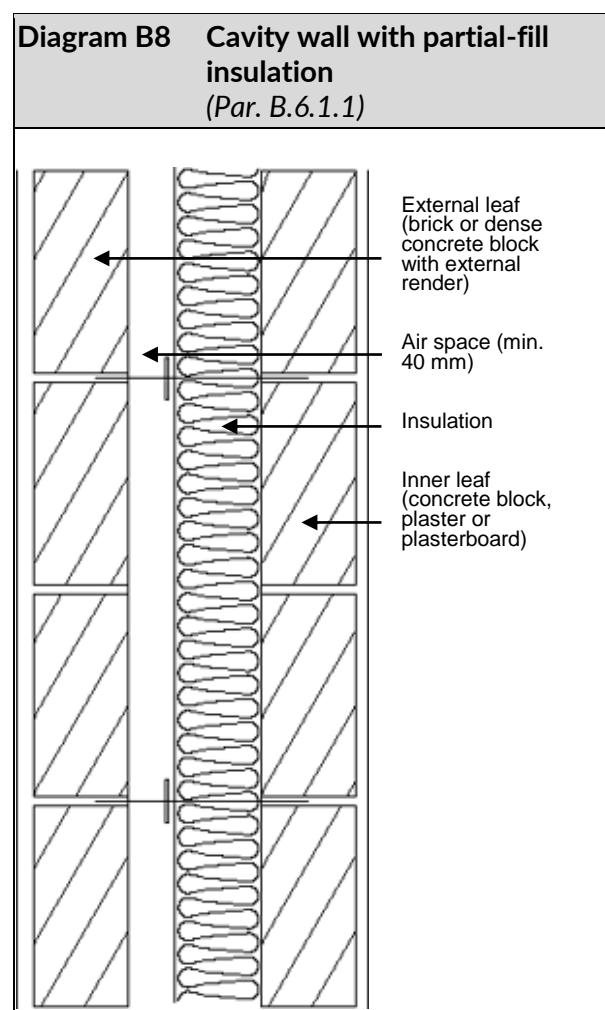

#### Installation guidelines and precautions

Insulation should be tight against the inner leaf. Any excess mortar should be cleaned off before fixing insulation. The insulation layer should be continuous and without gaps. Insulation batts should butt tightly against each other. Mortar droppings on batts should be avoided. Batt should be cut and trimmed to fit tightly around openings, cavity trays,



---

lintels, sleeved vents and other components bridging the cavity, and should be adequately supported in position. BRE “Good Building Guide 68 Part 2 Installing thermal insulation: Good site practice” provides further guidance on installing insulation in cavity walls.

Critical locations where care should be taken to limit thermal bridging include lintels, jambs, sills, roof/wall junctions and wall/floor junctions. The method of cavity closure used should not cause thermal bridging at the roof/wall junction (see Acceptable Construction Details, section 1 details).

#### **B.6.1.2 W1(b): As W1(a) except with insulation partly in cavity and partly as internal lining**

If composite boards of plasterboard backed with insulation (of similar conductivity to that used in the cavity) are used internally, then the total insulation thickness (cavity plus internal) may be used to calculate the U-value. If internal insulation is placed between timber studs/battens, then the insulation must be treated as two separate layers with the bridging effect allowed for in the internal layer (similar to Example A2 in Appendix A).

Where the thermal conductivity of the insulation is different, the material on the warm side (i.e. internally) should have a vapour resistance no lower than the insulation on the cold side (i.e. in the cavity).

Lower U-values, or reduced insulation thickness, can be achieved by using insulating concrete blockwork (rather than dense concrete) between the cavity and internal insulation.

Insulation partly in cavity and partly as internal lining helps minimise thermal bridging. Internal insulation limits thermal bridging at floor and roof junctions, whereas cavity insulation minimises thermal bridging at separating walls and internal fixtures.

#### **Installation guidelines and precautions**

Installation of insulation in the cavity should follow the guidelines given above for construction W1(a) (partial-fill cavity insulation), and installation of the internal lining should follow the guidelines given below for construction W4 (hollow-block). BRE “Good Building Guide 68 Part 2 Installing thermal insulation: Good site practice” provides further guidance on installing insulation in cavity walls.

#### **B.6.2 Construction W2: Cavity walls, insulation in cavity, no residual cavity (full-fill)**

The insulation fully fills the cavity. Insulation may be in the form of semi-rigid or rigid batts installed as wall construction proceeds, or loose-fill material blown into the cavity after the wall is constructed; the former is considered here. Insulation material suitable for cavity fill should not absorb water by capillary action and should not transmit water from outer to inner leaf. Such insulation may extend below damp proof coursing (dpc) level.

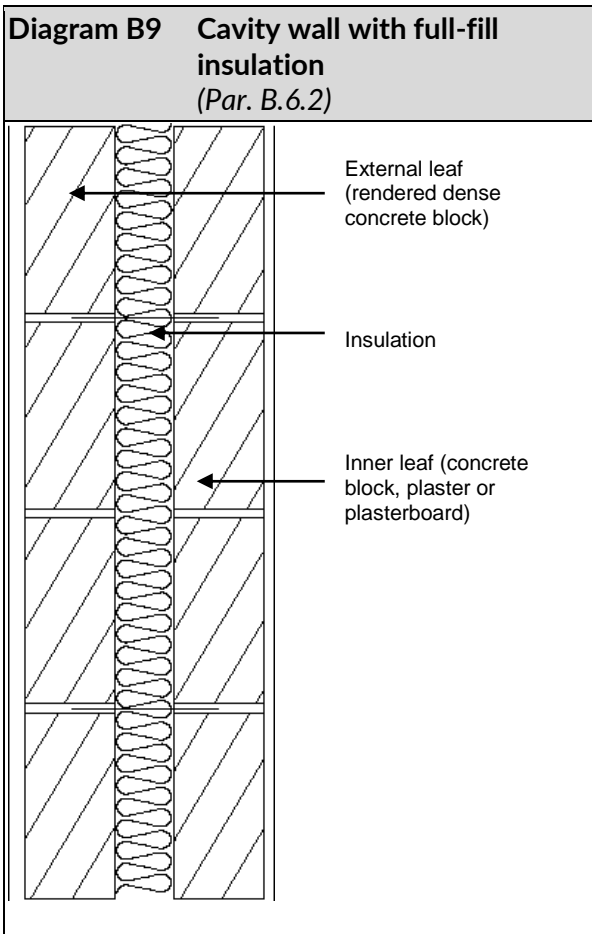

The insulation thickness required to achieve a given U-value may be reduced by using insulating concrete blocks for the inner leaf, as advised in W1(a) above.

#### Installation guidelines and precautions

Only certified insulation products should be used, and the installation and other requirements specified in such certificates should be fully complied with. In particular, regard should be had to the exposure conditions under which use is certified and any limitations on external finish associated therewith.

Guidance on minimising air gaps and infiltration in partial-fill cavity insulation applies also to full-fill insulation. Similar issues regarding avoidance of thermal bridging as for partial-fill construction apply.

BRE "Good Building Guide 68 Part 2 Installing

thermal insulation: Good site practice" provides further guidance on installing insulation in cavity walls.

#### B.6.3 Construction W3: Timber frame wall, brick or rendered concrete block external leaf

##### B.6.3.1 W3(a): Insulation between studs

The insulation is installed between studs, whose depth equals or exceeds the thickness of insulation specified.

In calculating U-values, the fractional area of timber bridging the insulation should be checked. Account should be taken of all repeating timber elements which fully bridge the insulation. In Table A2, a fractional area of 15 % is given as the default percentage and is used in Example A2 to calculate the upper and lower thermal resistance of the bridged construction.

**Diagram B10 Timber frame wall, insulation between framing timbers**  
(Par. B.6.3.1)

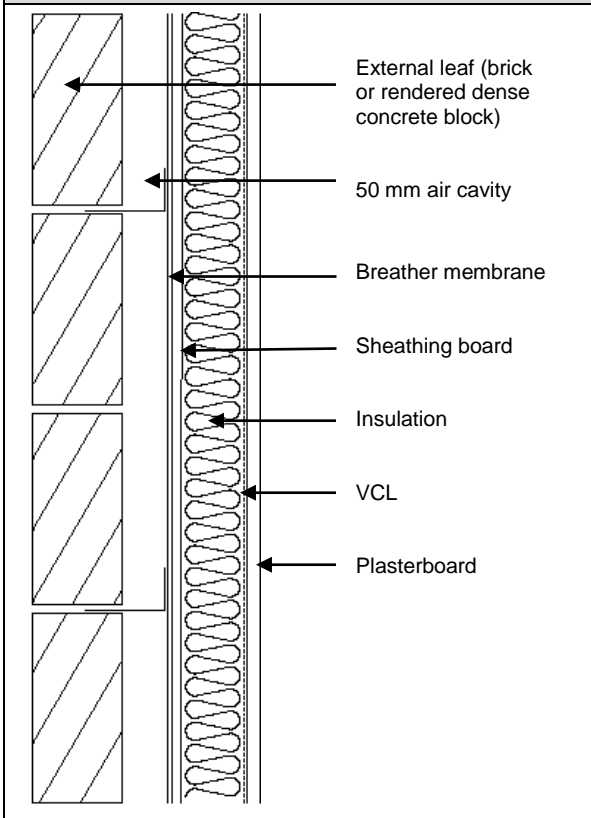

### B.6.3.2W3(b): Insulation between and across studs

Where the chosen stud depth is not sufficient to accommodate the required thickness of insulation, insulation can be installed to the full depth between the studs with additional insulation being provided as an internal lining. This additional insulation may be either in the form of plasterboard/insulation composite board or insulation between timber battens, to which the plasterboard is fixed.

The VCL should be on the warm side of the insulation. If different types of insulation are used between and inside the studs, the vapour resistance of the material between the studs should not exceed that of the material across them (see B.4 regarding VCLs).

#### Installation guidelines and precautions

Air gaps in the insulation layer, and between it and the vapour barrier, should be avoided. Insulation batts should be friction fitted between studs to minimise gaps between insulation and joists. Adjacent insulation pieces should butt tightly together. Particular care is needed to fill gaps between closely-spaced studs at wall/wall and wall/floor junctions, and at corners of external walls.

A VCL should be installed on the warm side of the insulation. There should be no layers of high vapour resistance on the cold side of the insulation.

Care is required to minimise thermal bridging of the insulation by timber noggings and other inserts (see Acceptable Construction Details, section 4 details).

**B.6.4 Construction W4: Hollow concrete block wall, rendered externally, internal insulation lining with plasterboard finish**

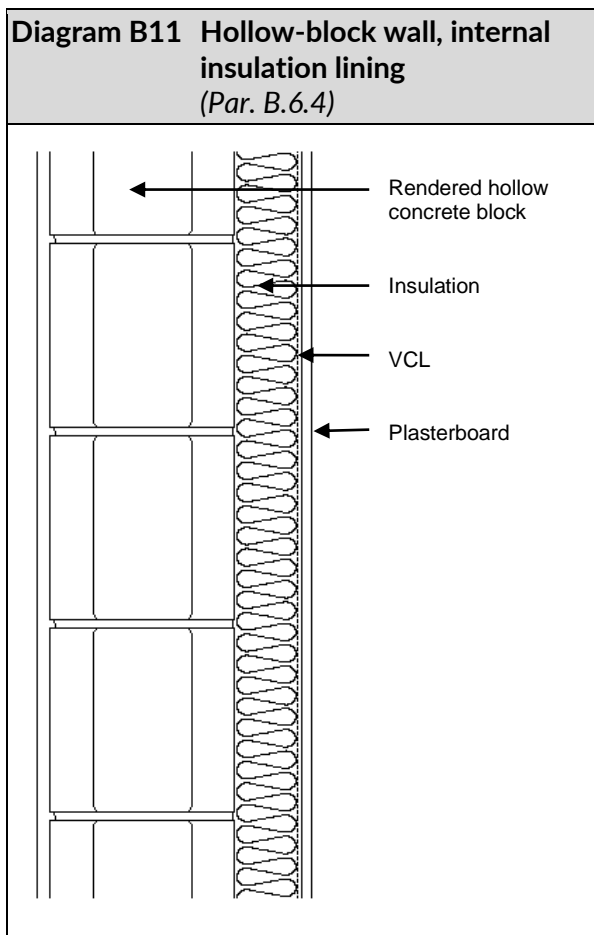

The insulation is installed on the inner face of the masonry walls. It may be installed between preservative-treated timber studs fixed to the wall, or in the form of composite boards of plaster backed with insulation, or as a combination of these.

**Installation guidelines and precautions**

**Exposure**

Table 11 of S.R.325:2013 (+A1:2014) provides guidance on exposure categories for single leaf masonry walls for the assessment of resistance to rain penetration.

**Air movement**

Air gaps in the insulation layer should be kept

to a minimum. If using insulation between timber studs, there should be no gaps between insulation and studs, between insulation and the VCL, between butt joints in the insulation, around service penetrations, etc. If using composite boards, they should be tightly butted at edges, and should provide complete and continuous coverage of the external wall.

When mounting composite boards on plaster dabs or timber battens, there is a danger that air will be able to circulate behind the insulation, reducing its effectiveness. To minimise such air movement, the air gap behind the boards should be sealed along top and bottom, at corners and around window and door openings, e.g. with continuous ribbon of plaster or timber studs. This also serves as a fire barrier.

**Condensation**

A suitable VCL should be installed on the warm side of the insulation to minimise the risk of interstitial condensation on the cold masonry behind the insulation. Care should be taken to avoid gaps in the VCL at all joints, edges and service penetrations. The location of service runs in the air gap on the cold side of the insulation should be avoided. Refer to paragraph B.4 for further guidance.

**Thermal bridging**

Care should be taken to minimise the impact of thermal bridging. Critical locations where care should be taken to limit thermal bridging include lintels, jambs, sills, roof/wall junctions and wall/floor junctions (see Acceptable Construction Details, section 6 details).

Other areas where there is a risk of significant thermal bridging include:

**Junctions with solid party walls and partitions**

Internal partition or party walls of solid dense concrete blockwork can create significant thermal bridge effects at junctions with single leaf masonry external walls (see Acceptable Construction Details, details 6.05 and 6.06).

### **Junctions with intermediate floors**

The external walls in the floor space of intermediate floors should be insulated and protected against vapour movement. Along the wall running parallel to the joists, insulation can be placed between the last joist and the wall. Where the joists are perpendicular to the wall, the insulation and VCL should be continuous through the intermediate floor space and should be carefully cut to fit around the joist ends (see Acceptable Construction Details, detail 6.04).

### **Stairs, cupboards and other fittings supported on or abutting the external wall**

Insulation should be carried through behind such fittings.

### **Ducts, e.g. soil and vent pipe ducts, against external walls**

Insulation should be continuous at all such ducts, i.e. the insulation should be carried through on either the external or internal side of such ducts. Where the insulation is on the external side, particular care should be taken to prevent ingress of cold external air where ducts etc. penetrate the insulation.

## **B.7 FLOOR CONSTRUCTIONS**

### **B.7.1 Construction F1: Ground floor: concrete slab-on-ground. Insulation under slab or under screed**

For continuous and uniform insulation under the full ground floor area, the insulation thickness required to achieve prescribed U-values for slab-on-ground floors varies depending on the floor area to exposed perimeter ratio as shown in Example A4 in Appendix A. When calculating the U-value, the ground conductivity should be taken as 2.0 W/mK and the full wall thickness as per design.

**Diagram B12 Concrete slab-on-ground floor, insulation under slab (Par. B.7.1)**

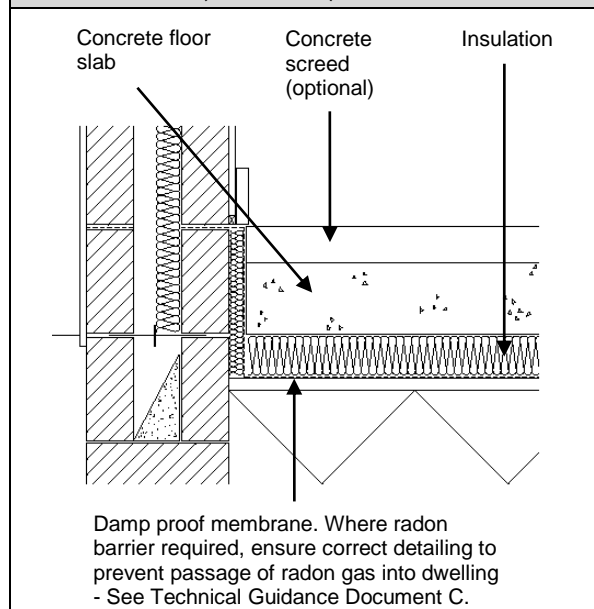

**Diagram B13 Concrete slab on ground floor, insulation under screed (Par. B.7.1)**

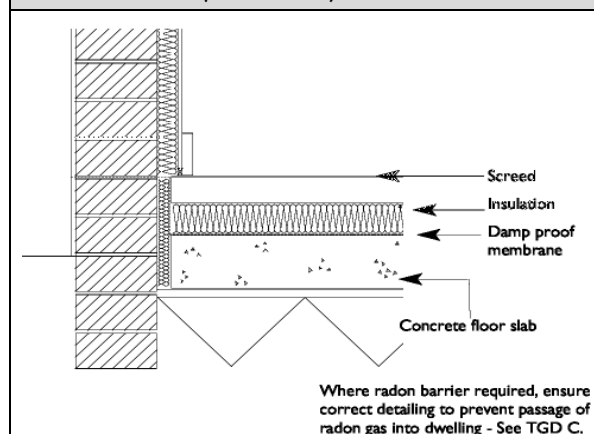

### **Installation guidelines and precautions**

The insulation may be placed above or below the damp proof membrane (dpm)/radon barrier. The insulation should not absorb moisture and, where placed below the dpm/radon barrier, should perform well under prolonged damp conditions and should not be degraded by any waterborne contaminants in the soil or fill.

The insulation should have sufficient load-bearing capacity to support the floor and its loading.

The insulation is laid horizontally over the whole area of the floor. Insulation boards should be tightly butted, and cut to fit tightly at edges and around service penetrations.

Care should be taken to prevent damage or dislodgement of insulation during floor laying. If the dpm is placed below the insulation, the joints between insulation boards should be taped to prevent wet screed from entering when being poured. If the slab/screed is power-floated, the exposed edges of perimeter insulation should be protected during power-floating, e.g. by boards, or the areas close to the edge of the floor should be hand trowelled.

Thermal bridging at floor/wall junctions should be minimised (see Acceptable Construction Details, details 1.01a and 6.02).

### B.7.2 Construction F2: Ground floor: suspended timber floor, insulation between joists

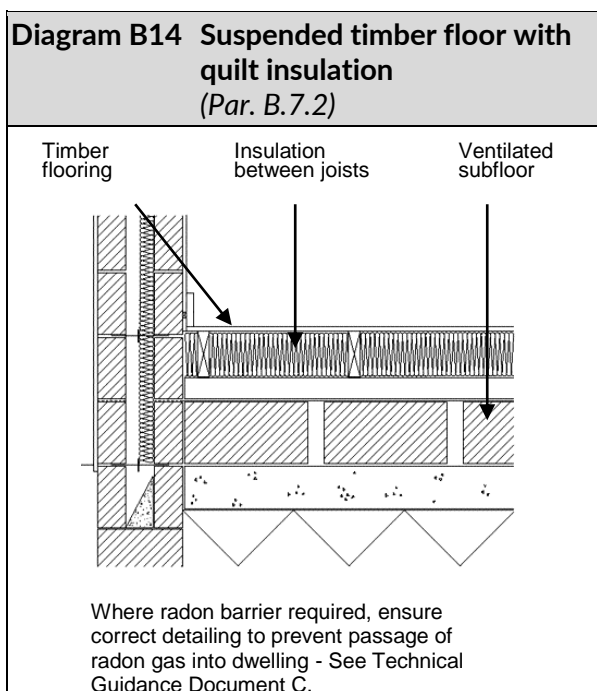

**Diagram B15 Suspended timber floor with rigid or semi-rigid board insulation**  
(Par. B.7.2)

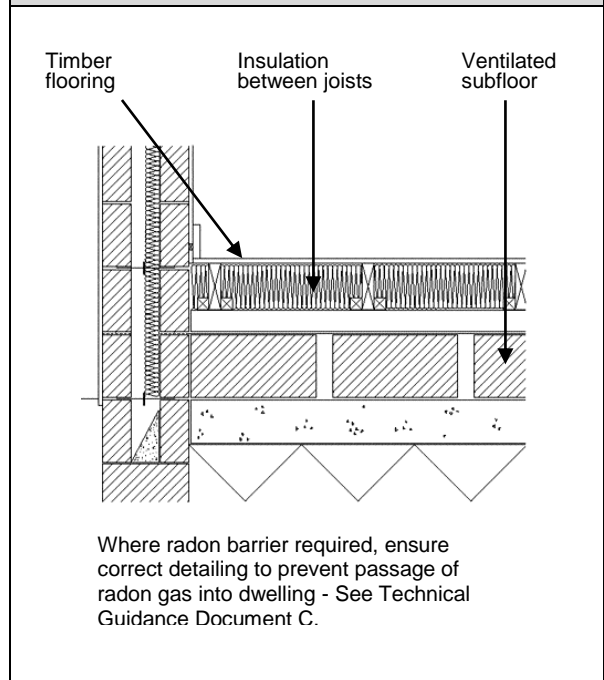

### Installation guidelines and precautions

Where mineral wool quilt insulation is used, the insulation is supported on polypropylene netting or a breather membrane draped over the joists and held against their sides with staples or battens. The full thickness of insulation should extend for the full width between joists. Insulation should not be draped over joists, but cut to fit tightly between them.

Alternatively, rigid or semi-rigid insulation boards, supported on battens nailed to the sides of the joists, may be used.

When calculating the U-value for a timber floor the fractional area of timber thermal bridging can be calculated or assumed as 11 % as per Table A2.

Thermal bridging, and air circulation around the insulation from the cold vented air space below, should be minimised. The insulation should fit tightly against the joists and the

flooring above. Careful placement of supporting battens (or staples) is required to achieve this. At floor/wall junctions the insulation should extend to the walls. The space between the last joist and the wall should be packed with insulation to the full depth of the joist. Where internal wall insulation is used, the floor and wall insulation should meet. Where cavity insulation is used, the floor insulation should be turned down on the internal face and overlap the cavity insulation, or insulating blocks used in the wall at this level (see Acceptable Construction Details, details 1.03 and 6.03).

Cross-ventilation should be provided to the sub-floor space to remove moisture.

Water pipes in the sub-floor space should be insulated to prevent freezing.

### B.7.3 Construction F3: Ground floor: suspended concrete floor

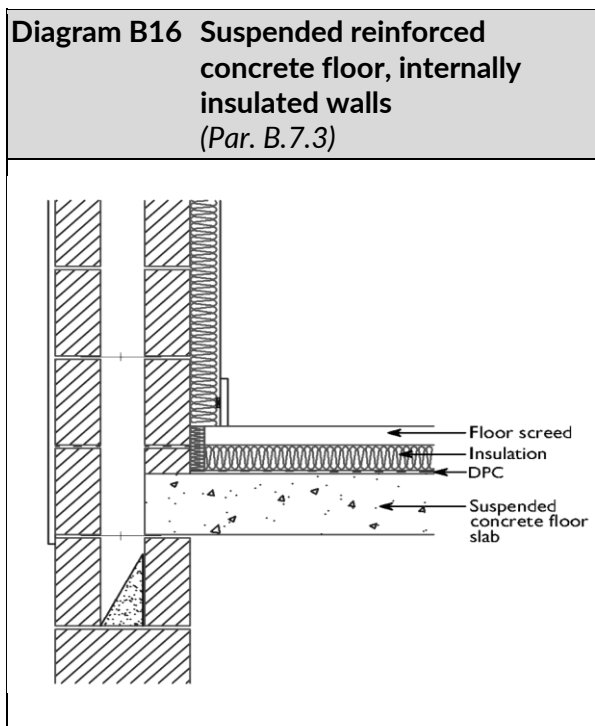

#### Installation guidance and precautions

If the walls are internally insulated, it is recommended that the floor insulation be

placed above the floor structure, since it can then connect with the wall insulation. Thermal bridging at the floor/wall junction is difficult to avoid when insulation is placed below the floor structure (see Acceptable Construction Details, details 6.01 and 6.02).

If the walls are cavity insulated, floor insulation can not connect with wall insulation, so some thermal bridging is inevitable. It can be minimised by using insulating blocks for the inner leaf between overlapping floor and wall insulation. Insulation and insulating blocks may be either above or below the floor structure, but above is recommended. This will allow the use of less dense blocks (of lower thermal conductivity), since they will not have to support the weight of the floor. Also, above the structure they will be above the dpc, where their lower moisture content will give a lower thermal conductivity than below the dpc. Heat loss from the floor can be further reduced by extending the cavity insulation down to, or below, the lower edge of the suspended floor.

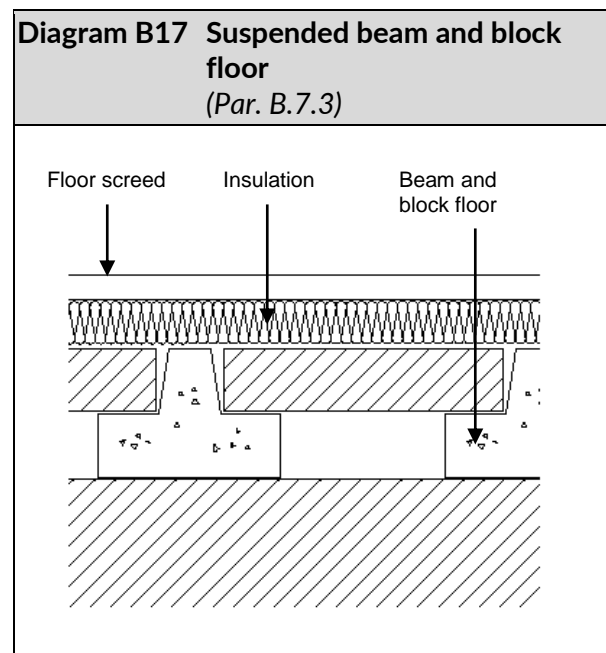

**B.7.4 Construction F4: Exposed floor: timber joists, insulation between joists**

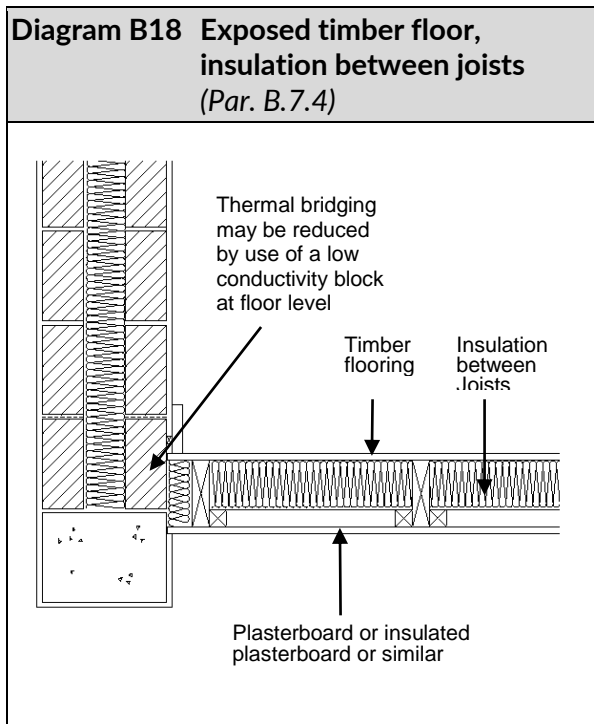

**Installation guidance and precautions**

The flooring on the warm side of the insulation should have a higher vapour resistance than the outer board on the cold side. If necessary, a vapour check should be laid across the warm side of the insulation. Methods of avoiding thermal bridging at junctions with internally insulated and cavity insulated walls are similar to those described for suspended timber ground floors above.

**B.7.5 Construction F5: Exposed floor: solid concrete, insulation external**

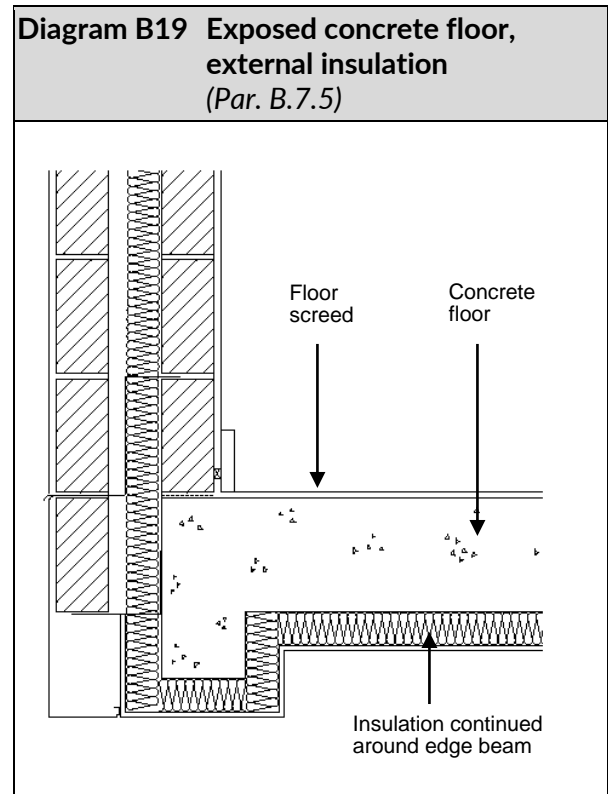

**Installation guidance and precautions**

If the walls are internally insulated, this floor construction is not recommended. Floor insulation should instead be located internally in order to connect with the wall insulation.

With cavity wall insulation, thermal bridging may be minimised by supporting the external leaf independently, and continuing the external floor insulation around the edgebeam to connect with the cavity insulation as shown in Diagram B19.



# Appendix C

## Reference values for calculation of MPEPC and MPCPC

### GENERAL

**C.1** This Appendix provides a set of reference values for the parameters of a DEAP calculation, which are used in connection with establishing an EPC and CPC for a dwelling for the purposes of demonstrating compliance with Regulation 8(a) for new dwellings. Table C1 is used to define a notional reference dwelling of the same size, i.e. same floor area and volume, and with the same area of opaque fabric elements, i.e. wall, roof and floor, as a dwelling being assessed. The total external window, rooflight and door area is taken to be 25 % of the dwelling floor area.

**C.2** The primary energy consumption and CO<sub>2</sub> emissions per unit floor area calculated for this reference dwelling are used to calculate

the primary energy performance coefficient (EPC) and carbon performance coefficient (CPC) respectively for a dwelling being assessed. These, in turn are compared to the MPEPC and MPCPC in order to demonstrate compliance for the dwelling being assessed. An example of a typical dwelling specification which complies with the MPEPC and MPCPC is given in Appendix E.

**C.3** The main heating system for space and water heating in the reference dwelling is assumed to be natural gas, while the secondary system is assumed to be an open fire. Some 10 % of space heating is assumed to be provided by the secondary heating method.

<b>Table C1 Reference Values</b>	
<b>Element or system</b>	<b>Specifications</b>
Total floor area, and dwelling volume	Same as actual dwelling
Opening areas (windows and doors)	25 % of total floor area, or sum of exposed roof and wall area, whichever is the lesser The above includes one opaque door of area 1.85 m <sup>2</sup> , any other doors are fully glazed
Walls	U = 0.27 W/m <sup>2</sup> K Area: Total wall area including windows and doors to be the same as actual dwelling
Roof	U = 0.16 W/m <sup>2</sup> K Area: Total area including any roof windows to be same as actual dwelling
Floor	U = 0.25 W/m <sup>2</sup> K Area: same as actual dwelling
Opaque door	U = 3.0 W/m <sup>2</sup> K
Windows and glazed doors	U = 2.2 W/m <sup>2</sup> K Double glazed, low-E hard coat Frame factor 0.7 Solar energy transmittance 0.72 Light transmittance 0.80
Living area fraction	Same as actual dwelling
Shading and orientation	All glazing oriented E/W; average overshadowing
Number of sheltered sides	2
Allowance for thermal bridging	0.11 x total exposed surface area (W/K)
Extract fans	3 for dwellings with floor area greater than 100 m <sup>2</sup> 2 for smaller dwellings
Draught lobby	None
Primary heating fuel (space and water)	Mains gas
Heating system	Boiler and radiators water pump in heated space

<b>Table C1 Reference Values (contd....)</b>	
<b>Element or system</b>	<b>Specifications</b>
Boiler	Seasonal efficiency 78 % room-sealed fanned flue
Heating system controls	Programmer + room thermostat + TRVs boiler interlock
Hot water system	Stored hot water, heated by boiler separate time control for space and water heating
Hot water cylinder	120 litre cylinder insulated with 35 mm of factory applied foam
Primary water heating losses	Primary pipework uninsulated cylinder temperature controlled by thermostat
Secondary space heating	Open fire
Low energy light fittings	None

# Appendix D

## Thermal bridging at junctions and around openings

---

### D.1 General

This Appendix deals with the assessment of discrete thermal bridging not taken account of in the calculation of the U-values of plane building elements, e.g. at junctions and around openings such as doors and windows. It gives guidance on:

- avoidance of mould growth and surface condensation, and
- limiting factors governing additional heat losses.

The guidance is based primarily on “BRE IP 1/06: Assessing the effects of thermal bridging at junctions and around openings”.

### D.2 Mould growth and surface condensation

The key factor used in assessing the risk of mould growth or surface condensation in the vicinity of thermal bridges is the temperature factor ( $f_{Rsi}$ ).

The temperature factor ( $f_{Rsi}$ ) is defined as follows:

$$f_{Rsi} = (T_{si} - T_e) / (T_i - T_e)$$

where: -

$T_{si}$  = minimum internal surface temperature,

$T_e$  = external temperature, and

$T_i$  = internal temperature.

For dwellings, the value of  $f_{Rsi}$  should be greater than or equal to 0.75, so as to avoid the risk of mould growth and surface condensation. For three-dimensional corners of ground floors this value may be reduced to 0.70, for all points within 10 mm of the point of lowest  $f_{Rsi}$ .

### D.3 Linear thermal transmittance and additional heat loss

The linear thermal transmittance ( $\psi$ ) describes the heat loss associated with a thermal bridge. This is a property of a thermal bridge and is the rate of heat flow per degree Kelvin per unit length of bridge that is not accounted for in the U-values of the plane building elements containing the thermal bridge. The transmission heat loss coefficient associated with non-repeating thermal bridges is calculated as:

$$H_{TB} = \sum(L \times \psi) \text{ (W/K)}$$

where L is the length of the thermal bridge over which  $\psi$  applies.

### D.4 Calculation procedures

The calculation procedure to establish both temperature factor ( $f_{Rsi}$ ) and the linear thermal transmittance ( $\psi$ ) is outlined in BRE IP 1/06. Details should be assessed in accordance with the methods described in I.S. EN ISO 10211:2017. These calculations of two dimensional or three dimensional heat flow require the use of numerical modeling software. To be acceptable, numerical modeling software should model the validation examples in I.S. EN ISO 10211:2017 with results that agree with the stated values of temperature and heat flow within the tolerance indicated in the standard for these examples. Several packages are available that meet this requirement.

Detailed guidance on decisions regarding specific input to the modeling software and the determination of certain quantities from the output of the software is contained in BRE Report BR 497 Conventions for calculating linear thermal transmittance and temperature factors. This guidance should be followed in carrying out modeling work so that different users of the same software package and users of different software packages can obtain correct and consistent results.

---

## D.5 Treatment of thermal bridging in DEAP calculation

Heat loss through thermal bridging is taken account of in the DEAP calculation. Two alternative methods of accounting for heat loss are possible:

- (a) Heat loss through thermal bridging can be accounted for in terms of a fraction ( $\gamma$ ) multiplied by the exposed surface area of the building. Where Acceptable Construction Details for sections 1 to 6 in the 2011 edition of the document "Limiting Thermal Bridging and Air Infiltration – Acceptable Construction Details" are used for all key junctions the value of ( $\gamma$ ) can be taken as 0.08. Where this is not the case, but this method of accounting for thermal bridging is used, the default value of ( $\gamma$ ) is taken to be 0.15.
- (b) Values of  $\psi$  can be determined from the results of numerical modeling, or they can be derived from measurement. The linear transmission heat loss coefficient ( $H_{TB}$ ) can then be calculated directly and included in the DEAP calculation. Values of  $\psi$  are given in Tables D1 to D6 of this Appendix for Acceptable Construction Details and for Appendix 2 of the 2011 edition "Limiting Thermal Bridging and Air Infiltration – Acceptable Construction Details" to allow this approach to be used for these details. Where Section 3 - internal insulation details are used the  $\psi$  values given in Table D6 may be used.

Table D1	Section 1 - Cavity Wall Insulation	Target U-values		
Junction detail Identifier 2011 Edition	Junction detail	U-value = 0.18 W/m <sup>2</sup> K, 150mm full-fill or partial fill cavity <sup>1,3</sup> (roof U = 0.16) (floor U = 0.18)	U-value = 0.15 W/m <sup>2</sup> K, 150mm full-fill or partial fill cavity and internal insulation <sup>2,3</sup> (roof U = 0.14) (floor U = 0.15)	U-value = 0.15 W/m <sup>2</sup> K, 200mm full-fill or partial fill cavity <sup>2,3</sup> (roof U = 0.14) (floor U = 0.15)
		ψ-value (W/mK)	ψ-value (W/mK)	ψ-value (W/mK)
<b>Section 1</b>	<b>Details</b>			
1.01a	Ground Floor - Insulation above slab	0.170	0.072	0.196
1.01b	Ground Floor - Insulation above slab plus lightweight block	0.080	0.042	0.093
1.02a	Ground Floor - Insulation below slab	0.163	0.108	0.191
1.02b	Ground Floor - Insulation below slab plus lightweight block	0.070	0.061	0.083
1.03	Timber Suspended Ground Floor	0.219	0.102	0.227
1.04	Concrete Intermediate Floor within a dwelling	0.000	0.039	0.000
1.04a	Concrete Separating Floor between dwellings <sup>6</sup>	0.064	0.087	0.045
1.05	Timber Intermediate Floor within a dwelling	-0.001	0.020	-0.001
1.05a	Timber Separating Floor between dwellings <sup>6</sup>	0.041	0.051	0.029
1.06.1	Masonry Solid Separating Wall (plan) <sup>6</sup>	0.045	0.066	0.032
1.06.2	Masonry Cavity Separating Wall (plan) <sup>6</sup>	0.051	0.072	0.036
1.07	Masonry Partition Wall	0.000	0.000	0.000
1.08	Stud Partition Wall	0.000	0.000	0.000
1.09/1.10	Eaves - Unventilated/Ventilated attic	0.049	0.030	0.053
1.11.1/ 1.12.1	Eaves - Unventilated/Ventilated - Insulated at ceiling	0.028	0.024	0.037
1.11.2/ 1.12.2	Eaves - Unventilated/Ventilated - Insulation between and under rafters - Dormer	0.014	0.013	0.013
1.13.1	Eaves - Ventilated - Insulation between and under rafters - Pitched ceiling	0.021	0.020	0.036
1.13.2	Eaves - Ventilated - Insulation between and under rafters - Pitched with flat ceiling	0.020	0.017	0.017
1.14	Eaves - Unventilated - Insulation between and over rafters - Dormer	0.009	0.011	0.034
1.15	Ventilated Roof - Attic floor level	0.272	0.152	0.210
1.16/1.17	Gable - Insulation between and under rafters - Unventilated/Ventilated rafter void	0.067	0.041	0.063
1.18	Gable - Insulation between and over rafters - Unventilated rafter void	0.096	0.058	0.071
1.19	Flat Roof - Eaves	0.040	0.039	0.038
1.20	Flat Roof - Parapet	0.152	0.059	0.206
1.21	Ope - Split Lintels - Steel and Concrete	-0.003	0.005	0.001
1.22	Ope - Perforated steel lintel (stainless steel)	0.261	0.138	0.236
1.23.1	Ope - Pre-stressed concrete lintels	-0.005	0.004	0.001
1.23.2	Ope - Pre-stressed concrete lintels - proprietary closer	0.007	0.012	0.006
1.24	Ope - Jamb with closer block	0.028	0.026	0.031
1.25	Ope - Jamb with proprietary cavity closer	0.006	0.011	0.006
1.26	Ope - Concrete Forward Sill	0.006	0.015	0.019
1.27.1	Corner	0.044	0.032	0.035
1.27.2	Inverted corner	-0.069	-0.053	-0.055

Table D1 (contd)	Section 1 - Cavity Wall Insulation	Target U-values		
Junction detail Identifier 2011 Edition	Junction detail	U-value = 0.18 W/m <sup>2</sup> K, 150mm full-fill or partial fill cavity <sup>1,3</sup> (roof U = 0.16) (floor U = 0.18)	U-value = 0.15 W/m <sup>2</sup> K, 150mm full-fill or partial fill cavity and internal insulation <sup>2,3</sup> (roof U = 0.14) (floor U = 0.15)	U-value = 0.15 W/m <sup>2</sup> K, 200mm full-fill or partial fill cavity <sup>2,3</sup> (roof U = 0.14) (floor U = 0.15)
		ψ-value (W/mK)	ψ-value (W/mK)	ψ-value (W/mK)
<b>Section G</b>	<b>General Details</b>			
G.01.1	Masonry Separating (cavity) Wall Head - Section <sup>6</sup>	0.511	0.484	0.484
G.01.2	Masonry Separating (solid) Wall Head - Section <sup>6</sup>	0.488	0.458	0.458
G.05.1	Solid Masonry Separating Wall through ground floor <sup>6</sup>	0.201	0.240	0.240
G.05.2	Solid Masonry (narrow) Partition Wall through ground floor	0.138	0.150	0.150
<b>Appendix 2</b>	<b>Details</b>			
Diagram 1	Galvanised Steel top hat lintel detail bridging masonry cavity wall	0.483	0.206	0.454
Diagram 2	Concrete Back sill detail (insulation below wood sill section)	0.383	0.174	0.395
Diagram 3	Eaves - Ventilated roof space - wall head closed with slate	0.072	0.054	0.131
	<b>Other Details</b>			
1.B.1	Balcony within dwelling <sup>4</sup>	0.000	0.000	0.000
1.B.2	Balcony between dwellings <sup>4,5</sup>	0.020	0.020	0.020

<sup>1</sup> ψ values for a Target U-value for the wall of 0.18 W/m<sup>2</sup>K for the construction type specified. The U-values of the flanking elements to the wall can vary from the flanking element target U-value as follows: Pitched roof insulation on slope, insulation on ceiling = 0.13 to 0.16 W/m<sup>2</sup>K; Flat Roof = 0.16 to 0.20 W/m<sup>2</sup>K; Ground Floor = 0.16 to 0.21 W/m<sup>2</sup>K.

<sup>2</sup> ψ values for a Target U-value for the wall of 0.15 W/m<sup>2</sup>K can be used for a range of U-values from of 0.12 W/m<sup>2</sup>K to 0.17 W/m<sup>2</sup>K for the construction type specified. The U-values of the flanking elements to the wall can vary from the flanking element target U-value as follows: Pitched roof insulation on slope, insulation on ceiling 0.11 to 0.16W/m<sup>2</sup>K; Flat Roof = 0.11 to 0.17 W/m<sup>2</sup>K; Ground Floor = 0.12 to 0.18 W/m<sup>2</sup>K.

<sup>3</sup> Where two building elements have one U-value above its target while the other is below its target U-value, the aggregate percentage change from the respective target U-values in the table should not exceed +20 % for the Psi (ψ) value to be valid, i.e. if for the 0.15 U-value wall, if the U-value was increased by 10 % above the wall target U-value (from 0.15 to 0.165), then the roof U-value could be at most 10 % below the roof target U-value (from 0.14 to 0.126), because the aggregate change would then be 20 %.

<sup>4</sup> This is an externally supported balcony (the balcony slab is not a continuation of the floorslab) where the wall insulation is continuous and not bridged by the balcony slab.

<sup>5</sup> Value of Ψ is applied to each dwelling.

<sup>6</sup> Psi value is for whole junction. Half the value should be applied to each dwelling on either side of the junction.

Table D2		Section 2 - External Insulation		Target U-values	
Junction detail Identifier 2011 Edition	Junction detail	U-value = 0.18 Wm <sup>2</sup> K <sup>1,3</sup> (roof U = 0.16) (floor U = 0.18)	U-value = 0.15 Wm <sup>2</sup> K <sup>2,3</sup> (roof U = 0.14) (floor U = 0.15)	ψ-value (W/mK)	ψ-value (W/mK)
<b>Section 2</b>	<b>Details</b>				
2.01	Ground Floor - Insulation above slab	0.131	0.145		
2.01a	Ground Floor - Insulation above slab	0.214	0.259		
2.02	Ground Floor - Insulation below slab	0.162	0.172		
2.02a	Ground Floor - Insulation below slab	0.235	0.247		
2.03	Timber Suspended Ground Floor	0.158	0.204		
2.03a	Timber Suspended Ground Floor	0.297	0.368		
2.04	Concrete Intermediate Floor within a dwelling	0.001	0.000		
2.04a	Concrete Separating Floor between dwellings <sup>6</sup>	0.071	0.048		
2.05	Masonry Separating Wall - plan <sup>6</sup>	0.049	0.033		
2.06	Masonry Partition Wall	0.000	0.000		
2.07	Stud Partition Wall	0.000	0.000		
2.08/2.09	Eaves - Unventilated/Ventilated roof space	0.067	0.074		
2.10.1/2.11.1	Eaves - Unventilated/Ventilated - Insulation between and under rafters - Dormer	0.050	0.055		
2.12.1	Eaves - Unventilated - Insulation between and over rafters - Pitched ceiling	0.016	0.031		
2.12.2	Eaves - Unventilated/Ventilated - Insulation between and under rafters - Pitched with flat ceiling	0.020	0.017		
2.13	Eaves - Unventilated - Insulation between and over rafters	0.013	0.027		
2.14	Ventilated Roof - Attic floor level	0.347	0.335		
2.15/2.16	Gable - Insulation between and under rafters - Unventilated/Ventilated rafter void	0.091	0.087		
2.17	Gable - Insulation between and over rafters - Unventilated rafter void	0.131	0.106		
2.18	Flat Roof - Eaves	0.046	0.045		
2.19	Flat Roof - Parapet	0.349	0.327		
2.20	Ope - Lintel	0.097	0.098		
2.21	Ope - Jamb	0.088	0.091		
2.22	Sill	0.149	0.109		
2.23.1	Corner	0.099	0.070		
2.23.2	Inverted corner	-0.141	-0.096		
<b>Section G</b>	<b>General Details</b>				
G.01.1	Masonry Separating Wall Head - Section <sup>6</sup>	0.511	0.484		
G.01.2	Masonry Separating Wall Head - Section <sup>6</sup>	0.488	0.458		
G.05.1	Solid Masonry Separating Wall through ground floor <sup>6</sup>	0.201	0.240		
G.05.2	Solid Masonry (narrow) Partition Wall through ground floor	0.138	0.150		
<b>Other Details</b>					
2.B.1	Balcony within dwelling <sup>4</sup>	0.000	0.000		
2.B.2	Balcony between dwellings <sup>4,5</sup>	0.020	0.020		

<sup>1</sup> ψ values for a Target U-value for the wall of 0.18 W/m<sup>2</sup>K for the construction type specified. The U-values of the flanking elements to the wall can vary from the flanking element target U-value as follows: Pitched roof insulation on slope, insulation on ceiling = 0.13 to 0.16 W/m<sup>2</sup>K; Flat Roof = 0.16 to 0.2 W/m<sup>2</sup>K; Ground Floor = 0.16 to 0.21 W/m<sup>2</sup>K.

<sup>2</sup> ψ values for a Target U-value for the wall of 0.15 W/m<sup>2</sup>K can be used for a range of U-values

---

from of 0.12 W/m<sup>2</sup>K to 0.17 W/m<sup>2</sup>K for the construction type specified. The U-values of the flanking elements to the wall can vary from the flanking element target U-value as follows: Pitched roof insulation on slope, insulation on ceiling 0.11 to 0.16 W/m<sup>2</sup>K; Flat Roof = 0.11 to 0.17 W/m<sup>2</sup>K; Ground Floor = 0.12 to 0.18.

<sup>3</sup> Where two building elements have one U-value above its target while the other is below its target U-value, the aggregate percentage change from the respective target U-values in the table should not exceed +20 % for the Psi ( $\psi$ ) value to be valid, i.e. if for the 0.15 U-value wall, if the U-value was increased by 10 % above the wall target U-value (from 0.15 to 0.165), then the roof U-value could be at most 10 % below the roof target U-value (from 0.14 to 0.126), because the aggregate change would then be 20 %.

<sup>4</sup> This is an externally supported balcony (the balcony slab is not a continuation of the floorslab) where the wall insulation is continuous and not bridged by the balcony slab.

<sup>5</sup> Value of  $\Psi$  is applied to each dwelling.

<sup>6</sup> Psi value is for whole junction. Half the value should be applied to each dwelling on either side of the junction.



Table D3	Section 3 - Internal Insulation	Target U-values	
Junction detail Identifier 2011 Edition	Junction detail	U-value = 0.18 Wm <sup>2</sup> K. Insulation between studs <sup>1,3</sup> (roof U = 0.16) (floor U = 0.18)	U-value = 0.15 Wm <sup>2</sup> K. Insulation between studs and internal Insulation <sup>2,3</sup> (roof U = 0.14) (floor U = 0.15)
		ψ-value (W/mK)	ψ-value (W/mK)
Section 3	Details	Refer to Table D6 for Section 3 Psi values	

Table D4	Section 4 - Timber Frame Construction	Target U-values	
Junction detail Identifier 2011 Edition	Junction detail	U-value = 0.18 Wm <sup>2</sup> K. Insulation between studs <sup>1,3</sup> (roof U = 0.16) (floor U = 0.18)	U-value = 0.15 Wm <sup>2</sup> K. Insulation between studs and internal Insulation <sup>2,3</sup> (roof U = 0.14) (floor U = 0.15)
		ψ-value (W/mK)	ψ-value (W/mK)
<b>Section 4</b>	<b>Details</b>		
4.01	Ground Floor - Insulation above slab	0.051	0.021
4.02	Ground Floor - Insulation below slab	0.205	0.125
4.03	Timber Suspended Ground Floor	0.063	0.046
4.04.1	Corner	0.062	0.030
4.04.2	Inverted corner	-0.004	-0.015
4.05	Timber Intermediate Floor within a dwelling	0.130	0.080
4.05a	Timber Separating floor between dwellings <sup>6</sup>	0.193	0.132
4.06	Separating Wall (plan) <sup>6</sup>	0.087	0.079
4.07	Separating Wall (section) <sup>6</sup>	0.236	0.236
4.08	Partition Wall	0.000	0.000
4.09/4.10	Eaves - Unventilated/Ventilated roof space	0.082	0.044
4.11.1/4.12.1	Eaves - Insulation between and under rafters - Unventilated/Ventilated rafter void - Dormer	0.054	0.039
4.12.2	Eaves - Insulation between and under rafters - Unventilated/Ventilated rafter void - Pitched Ceiling Dormer	0.014	0.013
4.13.1	Eaves - Ventilated - Insulation between and under rafters - Pitched Ceiling	0.075	0.040
4.13.2	Pitch ceiling/Insulation on flat	0.020	0.017
4.14	Eaves - Unventilated - Insulation between and over rafters	0.064	0.031
4.15	Ventilated Roof - Attic floor level	0.081	0.051
4.16/4.17	Gable - Insulation between and under rafters - Unventilated/Ventilated rafter void	0.060	0.024
4.18	Gable - Insulation between and over rafters - Unventilated rafter void	0.062	0.037
4.19	Flat Roof - Parapet	0.041	0.046
4.20	Ope - Lintel	0.144	0.084
4.21	Ope - Jamb	0.064	0.043
4.22	Ope - Sill	0.048	0.034
4.23.1	Timber Frame Separating Wall through ground floor	0.118	0.149
4.23.2	Timber Frame Partition Wall through ground floor	0.074	0.096
<b>Section G General Details</b>			
G.01.1	Masonry Separating Wall Head - Section <sup>6</sup>	0.511	0.484
G.01.2	Masonry Separating Wall Head - Section <sup>6</sup>	0.488	0.458
G.05.1	Solid Masonry Separating Wall through ground floor <sup>6</sup>	0.201	0.240
<b>Other Details</b>			
4.B.1	Balcony within dwelling <sup>4</sup>	0.000	0.000
4.B.2	Balcony between dwellings <sup>4,5</sup>	0.020	0.020

<sup>1</sup> ψ values for a Target U-value for the wall of 0.18 W/m<sup>2</sup>K for the construction type specified. The U-values of the flanking elements to the wall can vary from the flanking element target U-value as follows: Pitched roof insulation on slope, insulation on ceiling = 0.13 to 0.16 W/m<sup>2</sup>K; Flat Roof = 0.16 to 0.2 W/m<sup>2</sup>K; Ground Floor = 0.16 to 0.21 W/m<sup>2</sup>K.

---

<sup>2</sup>  $\psi$  values for a Target U-value for the wall of 0.15 W/m<sup>2</sup>K can be used for a range of U-values from of 0.12 W/m<sup>2</sup>K to 0.17 W/m<sup>2</sup>K for the construction type specified. The U-values of the flanking elements to the wall can vary from the flanking element target U-value as follows: Pitched roof insulation on slope, insulation on ceiling 0.11 to 0.16W/m<sup>2</sup>K; Flat Roof = 0.11 to 0.17 W/m<sup>2</sup>K; Ground Floor = 0.12 to 0.18.

<sup>3</sup> Where two building elements have one U-value above its target while the other is below its target U-value, the aggregate percentage change from the respective target U-values in the table should not exceed +20 % for the Psi ( $\psi$ ) value to be valid, i.e. if for the 0.15 U-value wall, if the U-value was increased by 10 % above the wall target U-value (from 0.15 to 0.165), then the roof U-value could be at most 10 % below the roof target U-value (from 0.14 to 0.126), because the aggregate change would then be 20 %.

<sup>4</sup> This is an externally supported balcony (the balcony slab is not a continuation of the floorslab) where the wall insulation is continuous and not bridged by the balcony slab.

<sup>5</sup> Value of  $\Psi$  is applied to each dwelling.

<sup>6</sup> Psi value is for whole junction. Half the value should be applied to each dwelling on either side of the junction.

Table D5		Section 5 - Steel Frame Construction	Target U-values	
Junction detail Identifier 2011 Edition	Junction detail	Hybrid steel frame U-value = 0.18 <sup>1,3</sup> (roof U = 0.16) (floor U = 0.18)	Hybrid steel frame with internal insulation U-value = 0.15 <sup>2,3</sup> (roof U = 0.14) (floor U = 0.15)	
Section 5	Details	ψ-value (W/mK)	ψ-value (W/mK)	
5.01	Ground Floor - Insulation above slab	0.033	0.038	
5.02	Ground Floor - Insulation below slab	0.141	0.106	
5.03	Lightweight Intermediate Floor	0.021	0.055	
5.04	Separating Wall (plan) <sup>6</sup>	0.103	0.114	
5.05	Separating Wall (section) <sup>6</sup>	0.520	0.189	
5.06	Stud Partition Wall	0.00	0.00	
5.07/5.08	Eaves - Unventilated/Ventilated Attic	0.030	0.026	
5.09.1/5.10.1	Eaves - Unventilated/Ventilated - Insulation between and under rafters - Dormer	0.032	0.026	
5.09.2/5.10.2	Eaves - Insulation between and under rafters - Unventilated/Ventilated void - Pitch Ceiling Dormer	0.014	0.013	
5.11.1	Eaves - Ventilated - Insulation between and under rafters - Pitched ceiling	0.011	0.012	
5.11.2	Eaves - Ventilated - Insulation between and under rafters - Pitched with flat ceiling	0.020	0.017	
5.12	Eaves - Insulation between and over rafters - Unventilated rafter void	0.007	0.009	
5.13	Ventilated and Unventilated Attic	0.111	0.049	
5.14/5.15	Gable - Insulation between and under rafters - Unventilated/Ventilated rafter void	0.049	0.034	
5.16	Gable - Insulation between and over rafters - Unventilated rafter void	0.055	0.037	
5.17	Flat Roof - Eaves	0.054	0.043	
5.18	Flat Roof - Parapet	0.093	0.054	
5.19	Ope - Lintel	0.006	0.016	
5.20	Ope - Jamb	0.023	0.019	
5.21	Ope - Sill	0.012	0.021	
5.22.1	Steel Separating Wall through ground floor	0.213	0.263	
5.22.2	Steel Partition Wall through ground floor	0.125	0.148	
5.23.1	Corner	0.075	0.029	
5.23.2	Inverted corner	-0.045	-0.043	
<b>Section G General Details</b>				
G.01.1	Masonry Separating Wall Head - Section <sup>6</sup>	0.511	0.484	
G.01.2	Masonry Separating Wall Head - Section <sup>6</sup>	0.488	0.458	
G.05.1	Solid Masonry Separating Wall through ground floor <sup>6</sup>	0.201	0.240	
<b>Other Details</b>				
5.B.1	Balcony within dwelling <sup>4</sup>	0.000	0.000	
5.B.2	Balcony between dwellings <sup>4,5</sup>	0.020	0.020	

<sup>1</sup> ψ values for a Target U-value for the wall of 0.18 W/m<sup>2</sup>K for the construction type specified. The U-values of the flanking elements to the wall can vary from the flanking element target U-value as follows: Pitched roof insulation on slope, insulation on ceiling = 0.13 to 0.16 W/m<sup>2</sup>K; Flat Roof = 0.16 to 0.2 W/m<sup>2</sup>K; Ground Floor = 0.16 to 0.21 W/m<sup>2</sup>K.

<sup>2</sup> ψ values for a Target U-value for the wall of 0.15 W/m<sup>2</sup>K can be used for a range of U-values from of 0.12 W/m<sup>2</sup>K to 0.17 W/m<sup>2</sup>K for the construction type specified. The U-values of the flanking elements to the wall can vary from the flanking element target U-value as follows: Pitched

---

roof insulation on slope, insulation on ceiling 0.11 to 0.16 W/m<sup>2</sup>K; Flat Roof = 0.11 to 0.17 W/m<sup>2</sup>K; Ground Floor = 0.12 to 0.18.

<sup>3</sup> Where two building elements have one U-value above its target while the other is below its target U-value, the aggregate percentage change from the respective target U-values in the table should not exceed +20 % for the Psi ( $\psi$ ) value to be valid, i.e. if for the 0.15 U-value wall, if the U-value was increased by 10 % above the wall target U-value (from 0.15 to 0.165), then the roof U-value could be at most 10 % below the roof target U-value (from 0.14 to 0.126), because the aggregate change would then be 20 %.

<sup>4</sup> This is an externally supported balcony (the balcony slab is not a continuation of the floorslab) where the wall insulation is continuous and not bridged by the balcony slab.

<sup>5</sup> Value of  $\Psi$  is applied to each dwelling.

<sup>6</sup> Psi value is for whole junction. Half the value should be applied to each dwelling on either side of the junction.

Table D6	Section 6 - Hollow Block Construction	Target U-values	
Junction detail Identifier 2011 Edition	Junction detail	Hollow Block with internal insulation U-value = 0.18 W/m <sup>2</sup> K <sup>1,3</sup> (roof U = 0.16) (floor U = 0.18)	Hollow Block with internal insulation U-value = 0.15 W/m <sup>2</sup> K <sup>2,3</sup> (roof U = 0.14) (floor U = 0.15)
		ψ-value (W/mK)	ψ-value (W/mK)
<b>Section 6</b>	<b>Details</b>		
6.01	Ground Floor - Insulation above slab	0.039	0.031
6.02	Ground Floor - Insulation below slab	0.050	0.039
6.03	Timber Suspended Ground Floor	0.029	0.021
6.04	Timber Intermediate Floor - Within a dwelling	0.101	0.081
6.05.1	Masonry Separating (solid) Wall - plan <sup>6</sup>	0.296	0.284
6.05.2	Masonry Separating (cavity) Wall - plan <sup>6</sup>	0.316	0.309
6.06	Masonry Partition Wall - plan	0.155	0.156
6.07	Stud Partition	0.000	0.000
6.08/6.09	Eaves - Unventilated/Ventilated roof space	0.021	0.021
6.10	Eaves - Insulation between and under rafters - ventilated rafter void - Dormer	0.022	0.022
6.10.2	Eaves - Insulation between and under rafters - Ventilated void - Pitched Ceiling Dormer	0.014	0.013
6.11	Eaves - Insulation between and under rafters - Ventilated rafter void - Pitched ceiling	0.003	0.002
6.11.2	Eaves - Ventilated - Insulation between and under rafters - Pitched with flat ceiling	0.020	0.020
6.12	Eaves - Unventilated - Insulation between and over rafters - Dormer	0.011	0.015
6.13	Ventilated Roof - Attic floor level	0.038	0.034
6.14/6.15	Gable - Insulation between and under rafters - Unventilated/Ventilated rafter void	0.026	0.022
6.16	Gable - Insulation between and over rafters - Unventilated rafter void	0.036	0.031
6.17	Flat Roof - Eaves	0.053	0.039
6.18	Flat Roof - Parapet	0.046	0.038
6.19	Ope - Lintel	0.037	0.042
6.20	Ope - Jamb	0.031	0.036
6.21	Ope - Sill	-0.004	0.003
6.C1	Corner	0.018	0.016
6.C2	Inverted Corner	-0.047	-0.042
<b>Section G</b>	<b>General Details</b>		
G.01.1	Masonry Separating (cavity) Wall Head - Section <sup>6</sup>	0.511	0.484
G.01.2	Masonry Separating (solid) Wall Head - Section <sup>6</sup>	0.488	0.458
G.05.1	Solid Masonry Separating Wall through ground floor <sup>6</sup>	0.201	0.245
G.05.2	Solid Masonry (narrow) Partition Wall through ground floor	0.138	0.150
<b>Other Details</b>			
6.B.1	Balcony within dwelling <sup>4</sup>	0.000	0.000
6.B.2	Balcony between dwellings <sup>4,5</sup>	0.020	0.020

<sup>1</sup> ψ values for a Target U-value for the wall of 0.18 W/m<sup>2</sup>K for the construction type specified. The U-values of the flanking elements to the wall can vary from the flanking element target U-value as follows: Pitched roof insulation on slope, insulation on ceiling = 0.13 to 0.16 W/m<sup>2</sup>K; Flat Roof = 0.16 to 0.2 W/m<sup>2</sup>K; Ground Floor = 0.16 to 0.21 W/m<sup>2</sup>K.

---

<sup>2</sup>  $\psi$  values for a Target U-value for the wall of 0.15 W/m<sup>2</sup>K can be used for a range of U-values from of 0.12 W/m<sup>2</sup>K to 0.16 W/m<sup>2</sup>K for the construction type specified. The U-values of the flanking elements to the wall can vary from the flanking element target U-value as follows: Pitched roof insulation on slope, insulation on ceiling = 0.11 to 0.16 W/m<sup>2</sup>K; Flat Roof = 0.11 to 0.17 W/m<sup>2</sup>K; Ground Floor = 0.12 to 0.18.

<sup>3</sup> Where two building elements have one U-value above its target while the other is below its target U-value, the aggregate percentage change from the respective target U-values in the table should not exceed +20 % for the Psi ( $\psi$ ) value to be valid, i.e. if for the 0.15 U-value wall, if the U-value was increased by 10 % above the wall target U-value (from 0.15 to 0.165), then the roof U-value could be at most 10 % below the roof target U-value (from 0.14 to 0.126), because the aggregate change would then be 20 %.

<sup>4</sup> This is an externally supported balcony (the balcony slab is not a continuation of the floorslab) where the wall insulation is continuous and not bridged by the balcony slab.

<sup>5</sup> Value of  $\Psi$  is applied to each dwelling.

<sup>6</sup> Psi value is for whole junction. Half the value should be applied to each dwelling on either side of the junction.

**Table D7: Example calculation of ( $\gamma$ ) value for DEAP for a 3 bed semi-detached house<sup>1</sup> using the actual lengths of the internal ACD key junctions and their psi-values from Appendix D.**

Table reference	Junction detail	Description	Target U-value(W/m <sup>2</sup> K)	Psi Value (W/mK)	Length (m)	Calculated Value Psi*L (W/K)
D1 - Cavity Wall Insulation	1.02a: Ground Floor - Insulation below slab	Ground Floor	U-value = 0.15, 150mm full-fill or partial fill cavity and internal insulation (roof U = 0.14)(floor U = 0.15)	0.108	23.000	2.484
D1 - Cavity Wall Insulation	1.24: Ope - Jamb with closer block	Jambs	U-value = 0.15, 150mm full-fill or partial fill cavity and internal insulation (roof U = 0.14)(floor U = 0.15)	0.026	27.000	0.702
D1 - Cavity Wall Insulation	1.21: Ope - Split Lintels - Steel and Concrete	Lintels	U-value = 0.15, 150mm full-fill or partial fill cavity and internal insulation (roof U = 0.14)(floor U = 0.15)	0.005	14.700	0.074
D1 - Cavity Wall Insulation	1.26: Ope - Concrete Forward Sill	Sills	U-value = 0.15, 150mm full-fill or partial fill cavity and internal insulation (roof U = 0.14)(floor U = 0.15)	0.015	12.850	0.193
D1 - Cavity Wall Insulation	1.05: Timber Intermediate Floor within a dwelling	Intermediate Floor	U-value = 0.15, 150mm full-fill or partial fill cavity and internal insulation (roof U = 0.14)(floor U = 0.15)	0.020	23.000	0.460
D1 - Cavity Wall insulation	1.09/1.10: Eaves - Unventilated/ Ventilated attic	Eaves	U-value = 0.15, 150mm full-fill or partial fill cavity and internal insulation (roof U = 0.14)(floor U = 0.15)	0.030	14.000	0.420
D1 - Cavity Wall Insulation	1.15: Ventilated Roof - Attic floor level	Gable	U-value = 0.15, 150mm full-fill or partial fill cavity and internal insulation (roof U = 0.14)(floor U = 0.15)	0.152	9.000	1.368
D1 - Cavity Wall Insulation	1.27.1: Corner	Corner	U-value = 0.15, 200mm full-fill or partial fill cavity (roof U = 0.14)(floor U = 0.15)	0.032	10.200	0.326
D1 - Cavity Wall Insulation	1.06.1: Masonry Solid Separating Wall (plan)	Separating Wall	U-value = 0.15, 150mm full-fill or partial fill cavity and internal insulation (roof U = 0.14)(floor U = 0.15)	0.033 (0.066/2)	10.200	0.334
D1 - Cavity Wall Insulation	G.01.2: Masonry Solid Separating Wall Head - Section	Separating Wall head	U-value = 0.15, 150mm full-fill or partial fill cavity and internal insulation (roof U = 0.14)(floor U = 0.15)	0.229 (0.458/2)	9.000	2.061
D1 - Cavity Wall Insulation	G.05.1: Solid Masonry separating wall through ground floor	Separating Wall ground floor	U-value = 0.15, 150mm full-fill or partial fill cavity and internal insulation (roof U = 0.14)(floor U = 0.15)	0.120 (0.240/2)	9.000	1.080
D1 - Cavity Wall Insulation	G.05.2: Solid Masonry (narrow) Partition Wall through ground floor	Partition wall through floor	U-value = 0.15, 150mm full-fill or partial fill cavity and internal insulation (roof U = 0.14)(floor U = 0.15)	0.150	9.000	1.350
D1 - Cavity Wall Insulation	1.07: Masonry Partition Wall	Partition wall vertical	U-value = 0.15, 150mm full-fill or partial fill cavity and internal insulation (roof U = 0.14)(floor U = 0.15)	0.000	5.100	0.000
$\Sigma(Lx \Psi) W/K$						10.852
Y-value (Exposed surface area - 243.3 m <sup>2</sup> ) (rounded to 2 decimals) W/m <sup>2</sup> K						10.852/243.3 = 0.05

<sup>1</sup>Construction:

Roof: pitched tiled roof, insulation laid on attic floor, part between joists and part over joists.

Walls: Cavity wall (dense concrete blocks) rendered externally, with partial fill insulation in the cavity and 50 mm cavity retained.

Floor: Concrete slab-on-ground floor with insulation under slab.

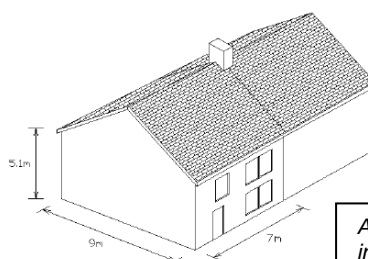

All dimensions are internal.



# Appendix E

## Achieving compliance with respect to EPC and CPC

**E.1** The following tables give a set of specifications which are calculated to achieve compliance for a typical 126 m<sup>2</sup> semi-detached house and 81m<sup>2</sup> apartment. Compliance with this requirement could also be achieved by a number of other combinations of measures.

<b>Table E1.1 Example A: Semi-detached dwelling with gas boiler for space heating and continuous mechanical extract ventilation</b>	
<b>Element or system</b>	<b>Specifications</b>
Dwelling size and shape	Semi-detached house, two-storey Overall internal dimensions: 7 m wide x 9 m deep x 5.1 m high Total floor area 126 m <sup>2</sup> Rectangular shape with no irregularities
Opening areas (windows and doors)	25 % of total floor area The above includes one opaque door of area 1.85 m <sup>2</sup> , any other doors are fully glazed
Walls	U = 0.13 W/m <sup>2</sup> K e.g. 150 mm cavity wall with 100 mm cavity insulation of thermal conductivity 0.022 W/mK and 60 mm internal insulation of conductivity 0.022 W/mK
Roof	U = 0.11 W/m <sup>2</sup> K e.g. 360 mm insulation of conductivity 0.04 W/mK, between and over ceiling joists
Floor	U = 0.14 W/m <sup>2</sup> K e.g. Slab-on-ground floor with 120 mm insulation of conductivity 0.023 W/mK
Opaque door	U = 1.5W/m <sup>2</sup> K
Windows and glazed doors	Triple glazed, low E (En = 0.05, soft coat) 20 mm gap, argon filled, PVC frames (U = 0.9 W/m <sup>2</sup> K, solar transmittance = 0.6)
Living area fraction	25 % of total floor area
Shading and orientation	28.7 m <sup>2</sup> glazing orientated E/W; 0.9 m <sup>2</sup> glazing orientated N; average overshadowing
Number of sheltered sides	2
Allowance for thermal bridging at element junctions	0.05 x total exposed surface area (W/m <sup>2</sup> K)
Internal heat capacity category	Medium
Ventilation system	Continuous Mechanical Extract Ventilation with SFP 0.2 W/(l/s)
Air permeability	Infiltration due to structure = 0.15ac/h (3m <sup>3</sup> /(hr.m <sup>2</sup> )@50pa)
Chimneys	None
Open flues	None
Intermittent Extract fans	1 (cooker exhaust)
Draught lobby	None
Primary heating fuel (space and water)	Mains gas
Heating system	Boiler and radiators with energy efficient water pump in heated space(energy consumption of 52kWh/yr)
Heat generator	Mains gas condensing boiler, seasonal efficiency 91.3 %, room-sealed, fanned flue
Heating System Controls	Boiler Interlock and Time and Temperature Zone Control
Hot water system	120 litre cylinder with 100 mm insulation Demand met by space heating boiler, separate time control for space and water heating, cylinder temperature controlled by thermostat 2 shower, each with 6 litres/min flow restrictor ,1 bath
Primary water heating losses	Insulated primary pipework between heat generator and cylinder
Secondary space heating	None
Low energy light fittings	100 % low energy lighting, conforming to the following specification: <ul style="list-style-type: none"> <li>· A+ Rated Bulbs with efficacy of 94 lumen/cW</li> <li>· Total =504 Watts</li> </ul>
Renewable Energy Source	1.15 kWp Photovoltaic east/west facing, no overshadowing, 30° ,8.6m <sup>2</sup> (7.5m <sup>2</sup> /kWp)

**Table E1.2 Example B: Semi-detached dwelling with gas boiler for space heating and natural ventilation with intermittent extract**

Element or system	Specifications
Dwelling size and shape	Semi-detached house, two-storey Overall internal dimensions: 7 m wide x 9 m deep x 5.1 m high Total floor area 126 m <sup>2</sup> Rectangular shape with no irregularities
Opening areas (windows and doors)	25 % of total floor area The above includes one opaque door of area 1.85 m <sup>2</sup> , any other doors are fully glazed
Walls	U = 0.13 W/m <sup>2</sup> K e.g. 150 mm cavity wall with 100 mm cavity insulation of thermal conductivity 0.022 W/mK and 60 mm internal insulation of conductivity 0.022 W/mK
Roof	U = 0.11 W/m <sup>2</sup> K e.g. 360 mm insulation of conductivity 0.04 W/mK, between and over ceiling joists
Floor	U = 0.14 W/m <sup>2</sup> K e.g. Slab-on-ground floor with 120 mm insulation of conductivity 0.023 W/mK
Opaque door	U = 1.5W/m <sup>2</sup> K
Windows and glazed doors	Triple glazed, low E (En = 0.05, soft coat) 20 mm gap, argon filled, PVC frames (U = 0.9 W/m <sup>2</sup> K, solar transmittance = 0.6)
Living area fraction	25 % of total floor area
Shading and orientation	28.7 m <sup>2</sup> glazing orientated E/W; 0.9 m <sup>2</sup> glazing orientated N; average overshadowing
Number of sheltered sides	2
Allowance for thermal bridging at element junctions	0.05 x total exposed surface area (W/m <sup>2</sup> K)
Internal heat capacity category	Medium
Ventilation system	Natural ventilation with intermittent extract fans
Air permeability	Infiltration due to structure = 0.25ac/h (5m <sup>3</sup> /(hr.m <sup>2</sup> )@50pa)
Chimneys	None
Open flues	None
Intermittent Extract fans	3
Draught lobby	None
Primary heating fuel (space and water)	Mains gas
Heating system	Boiler and radiators with energy efficient water pump in heated space(energy consumption of 52kWh/yr)
Heat generator	Mains gas condensing boiler, seasonal efficiency 91.3 %, room-sealed, fanned flue
Heating System Controls	Boiler Interlock and Time and Temperature Zone Control
Hot water system	120 litre cylinder with 100 mm insulation Demand met by space heating boiler, separate time control for space and water heating, cylinder temperature controlled by thermostat 2 showers, each with 6 litres/min flow restrictor ,1 bath
Primary water heating losses	Insulated primary pipework between heat generator and cylinder
Secondary space heating	None
Low energy light fittings	100 % low energy lighting, conforming to the following specification: · A+ Rated Bulbs with efficacy of 94 lumen/cW · Total =504 Watts
Renewable Energy Source	1.25 kWp Photovoltaic east/west facing, no overshadowing, 30° ,9.38m <sup>2</sup> (7.5m <sup>2</sup> /kWp)

**Table E1.3 Example C: Semi-detached dwelling with gas boiler for space heating and mechanical ventilation with heat recovery**

Element or system	Specifications
Dwelling size and shape	Semi-detached house, two-storey Overall internal dimensions: 7 m wide x 9 m deep x 5.1 m high Total floor area 126 m <sup>2</sup> Rectangular shape with no irregularities
Opening areas (windows and doors)	25 % of total floor area The above includes one opaque door of area 1.85 m <sup>2</sup> , any other doors are fully glazed
Walls	U = 0.13 W/m <sup>2</sup> K e.g. 150 mm cavity wall with 100 mm cavity insulation of thermal conductivity 0.022 W/mK and 60 mm internal insulation of conductivity 0.022 W/mK
Roof	U = 0.11 W/m <sup>2</sup> K e.g. 360 mm insulation of conductivity 0.04 W/mK, between and over ceiling joists
Floor	U = 0.14 W/m <sup>2</sup> K e.g. Slab-on-ground floor with 120 mm insulation of conductivity 0.023 W/mK
Opaque door	U = 1.5W/m <sup>2</sup> K
Windows and glazed doors	Triple glazed, low E (En = 0.05, soft coat) 20 mm gap, argon filled, PVC frames (U = 0.9 W/m <sup>2</sup> K, solar transmittance = 0.6)
Living area fraction	25 % of total floor area
Shading and orientation	28.7 m <sup>2</sup> glazing orientated E/W; 0.9 m <sup>2</sup> glazing orientated N; average overshading
Number of sheltered sides	2
Allowance for thermal bridging at element junctions	0.05 x total exposed surface area (W/m <sup>2</sup> K)
Internal heat capacity category	Medium
Ventilation system	Mechanical Ventilation with Heat Recovery, SFP =0.8, Heat Recovery Efficiency=85 %, Insulated Ductwork
Air permeability	Infiltration due to structure = 0.15ac/h (3m <sup>3</sup> /(hr.m <sup>2</sup> )@50pa)
Chimneys	None
Open flues	None
Intermittent Extract fans	1 (cooker exhaust)
Draught lobby	None
Primary heating fuel (space and water)	Mains gas
Heating system	Boiler and radiators with energy efficient water pump in heated space(energy consumption of 52kWh/yr)
Heat generator	Mains gas condensing boiler, seasonal efficiency 91.3 %, room-sealed, fanned flue
Heating System Controls	Boiler Interlock and Time and Temperature Zone Control
Hot water system	120 litre cylinder with 100 mm insulation Demand met by space heating boiler, separate time control for space and water heating, cylinder temperature controlled by thermostat 2 showers, each with 6 litres/min flow restrictor ,1 bath
Primary water heating losses	Insulated primary pipework between heat generator and cylinder
Secondary space heating	None
Low energy light fittings	100 % low energy lighting, conforming to the following specification: <ul style="list-style-type: none"> <li>· A+ Rated Bulbs with efficacy of 94 lumen/cW</li> <li>· Total =504 Watts</li> </ul>
Renewable Energy Source	0.9 kWp Photovoltaic east/west facing, no overshading, 30°, 6.8m <sup>2</sup> (7.5m <sup>2</sup> /kWp)

<b>Table E1.4 Example D: Semi-detached dwelling with heat pumps for space heating and continuous mechanical extract ventilation</b>	
<b>Element or system</b>	<b>Specifications</b>
Dwelling size and shape	Semi-detached house, two-storey Overall internal dimensions: 7 m wide x 9 m deep x 5.1 m high Total floor area 126 m <sup>2</sup> Rectangular shape with no irregularities
Opening areas (windows and doors)	25 % of total floor area The above includes one opaque door of area 1.85 m <sup>2</sup> , any other doors are fully glazed
Walls	U = 0.13 W/m <sup>2</sup> K e.g. 150 mm cavity wall with 100 mm cavity insulation of thermal conductivity 0.022 W/mK and 60 mm internal insulation of conductivity 0.022 W/mK
Roof	U = 0.11 W/m <sup>2</sup> K e.g. 360 mm insulation of conductivity 0.04 W/mK, between and over ceiling joists
Floor	U = 0.14 W/m <sup>2</sup> K e.g. Slab-on-ground floor with 120 mm insulation of conductivity 0.023 W/mK
Opaque door	U = 1.5W/m <sup>2</sup> K
Windows and glazed doors	Triple glazed, low E (En = 0.05, soft coat) 20 mm gap, argon filled, PVC frames (U = 0.9 W/m <sup>2</sup> K, solar transmittance = 0.63)
Living area fraction	25 % of total floor area
Shading and orientation	28.7 m <sup>2</sup> glazing orientated E/W; 0.9 m <sup>2</sup> glazing orientated N; average overshadowing
Number of sheltered sides	2
Allowance for thermal bridging at element junctions	0.05 x total exposed surface area (W/m <sup>2</sup> K)
Internal heat capacity category	Medium
Ventilation system	Continuous Mechanical Extract Ventilation with SFP 0.2 W/(l/s)
Air permeability	Infiltration due to structure = 0.15ac/h(3m <sup>3</sup> /(hr.m <sup>2</sup> )@50pa)
Chimneys	None
Open flues	None
Intermittent Extract fans	1 (cooker exhaust)
Draught lobby	None
Primary heating fuel (space and water)	Electricity
Heating system	Low temperature radiators
Heat generator	Heat Pump; Space Heating efficiency =375 %; Hot Water efficiency = 200 %
Heating System Controls	Time and Temperature Zone Control
Hot water system	As for space heating, cylinder 250 litre with 100 mm insulation Demand met by heat pump, separate time control for space and water heating, cylinder temperature controlled by thermostat 2 showers, each with 6 litres/min flow restrictor ,1 bath
Primary water heating losses	Insulated primary pipework between heat generator and cylinder
Secondary space heating	None
Low energy light fittings	100 % low energy lighting, conforming to the following specification: <ul style="list-style-type: none"> <li>· A+ Rated Bulbs with efficacy of 94 lumen/cW</li> <li>· Total =504 Watts</li> </ul>
Renewable Energy Source	Environmental energy from heat pump

<b>Table E1.5 Example E Mid Floor Apartment Dwelling space heating-gas boiler and mechanical ventilation with heat recovery</b>	
<b>Element or system</b>	<b>Specifications</b>
Dwelling size and shape	Apartment Dwelling, single-storey Overall internal dimensions: 9 m wide x 9m deep x 2.45 m high Total floor area 81 m <sup>2</sup> Rectangular shape with no irregularities
Opening areas (windows and doors)	27 % of total floor area The above includes one opaque door of area 1.85 m <sup>2</sup> , any other doors are fully glazed
Walls	External U = 0.13 W/m <sup>2</sup> K e.g. 150 mm cavity wall with 100 mm cavity insulation of thermal conductivity 0.022 W/mK and 60 mm internal insulation of conductivity 0.022 W/mK Wall Adjoining Unheated Corridor U-value 0.194 W/ m <sup>2</sup> K U-value of Original Wall 2.1 W/ m <sup>2</sup> K Resistance of Unheated Corridor = 4.7 m <sup>2</sup> K/W, based on ACH 0.15, Wall U value of 0.13 W/m <sup>2</sup> K and Window U value of 0.9 W/m <sup>2</sup> K. No heat loss floor or roof in corridor.
Opaque door	U = 1.5W/m <sup>2</sup> K
Windows and glazed doors	Triple glazed, low E (En = 0.05, soft coat) 20 mm gap, argon filled, PVC frames (U = 0.9 W/m <sup>2</sup> K, solar transmittance = 0.6)
Living area fraction	50 % of total floor area
Shading and orientation	10.8 m <sup>2</sup> glazing orientated E/W; 9 m <sup>2</sup> glazing orientated S; average overshadowing
Number of sheltered sides	2
Allowance for thermal bridging at element junctions	0.05 x total exposed surface area (W/m <sup>2</sup> K)
Internal heat capacity category	Medium
Ventilation system	Mechanical Ventilation with Heat Recovery, SFP =0.8, Heat Recovery Efficiency=85 %, Insulated Ductwork
Air permeability	Infiltration due to structure = 0.15ac/h (3m <sup>3</sup> /(hr.m <sup>2</sup> )@50pa
Chimneys	None
Open flues	None
Intermittent Extract fans	1 (cooker exhaust)
Draught lobby	One
Primary heating fuel (space and water)	Mains gas
Heating system	Radiators
Heat Generator	Mains gas condensing boiler, seasonal efficiency 91.3 %, room-sealed, fanned flue
Heating System Controls	Boiler Interlock, Time and Temperature Zone Control
Hot water system	120 litre with 100 mm insulation Demand met by space heating boiler, separate time control for space and water heating, cylinder temperature controlled by thermostat, 1 shower with 6 litres/min flow restrictor, 1 bath
Primary water heating losses	Insulated primary pipework between heat generator and cylinder
Secondary space heating	None
Low energy light fittings	100 % low energy lighting, conforming to the following specification: <ul style="list-style-type: none"> <li>· A+ Rated Bulbs with efficacy of 94 lumen/cW</li> <li>· Total =324 Watts</li> </ul>
Renewable Energy Source	0.6 kWp Photovoltaic east/west facing, no overshadowing, 30°, 4.5m <sup>2</sup> (7.5m <sup>2</sup> /kWp)

**Table E1.6 Example F Mid Floor Apartment Dwelling space heating-heat pump and continuous mechanical extract ventilation**

Element or system	Specifications
Dwelling size and shape	Apartment Dwelling, single-storey Overall internal dimensions: 9 m wide x 9m deep x 2.45 m high Total floor area 81 m <sup>2</sup> Rectangular shape with no irregularities
Opening areas (windows and doors)	27 % of total floor area The above includes one opaque door of area 1.85 m <sup>2</sup> , any other doors are fully glazed
Walls	External U = 0.13 W/m <sup>2</sup> K e.g. 150 mm cavity wall with 100 mm cavity insulation of thermal conductivity 0.022 W/mK and 60 mm internal insulation of conductivity 0.022 W/mK Wall Adjoining Unheated Corridor U-value 0.194 W/ m <sup>2</sup> K U-value of Original Wall 2.1 W/ m <sup>2</sup> K Resistance of Unheated Corridor = 4.7 m <sup>2</sup> K/W, based on ACH 0.15, Wall U value of 0.13 W/m <sup>2</sup> K and Window U value of 0.9 W/m <sup>2</sup> K. No heat loss floor or roof in corridor.
Opaque door	U = 1.5W/m <sup>2</sup> K
Windows and glazed doors	Triple glazed, low E (En = 0.05, soft coat) 20 mm gap, argon filled, PVC frames (U = 0.9 W/m <sup>2</sup> K, solar transmittance = 0.6)
Living area fraction	50 % of total floor area
Shading and orientation	10.8 m <sup>2</sup> glazing orientated E/W; 9 m <sup>2</sup> glazing orientated S; average overshadowing
Number of sheltered sides	2
Allowance for thermal bridging at element junctions	0.05 x total exposed surface area (W/m <sup>2</sup> K)
Internal heat capacity category	Medium
Ventilation system	Continuous Mechanical Extract Ventilation with SFP 0.2 W/(l/s)
Air permeability	Infiltration due to structure = 0.15ac/h (3m <sup>3</sup> /(hr.m <sup>2</sup> )@50pa
Chimneys	None
Open flues	None
Intermittent Extract fans	1 (cooker exhaust)
Draught lobby	One
Primary heating fuel (space and water)	Electricity
Heating system	Low Temperature Radiators
Heat Generator	Heat Pump; Space Heating efficiency =400 %; Hot Water efficiency = 210 %
Heating System Controls	Boiler Interlock, Time and Temperature Zone Control
Hot water system	180 litre with 100 mm insulation Demand met by heat pump, separate time control for space and water heating, cylinder temperature controlled by thermostat,1 shower with 6 litres/min flow restrictor, 1 bath.
Primary water heating losses	Insulated primary pipework between heat generator and cylinder
Secondary space heating	None
Low energy light fittings	100 % low energy lighting, conforming to the following specification: · A+ Rated Bulbs with efficacy of 94 lumen/cW · Total =324 Watts
Renewable Energy Source	Environmental heat from heat pump

**E.2** The standardized primary energy consumption and CO<sub>2</sub> emissions for space heating, water heating, ventilation and lighting for this dwelling, as calculated by DEAP, are given in Table E2, expressed per m<sup>2</sup> of floor area per annum. The table shows that the calculated EPC complies with the MPEPC requirement of 0.30, and the CPC complies with the MPCPC requirement of 0.35.

<b>Table E2 Example Dwellings - Results</b>						
	<b>Example A - Semi-detached heated by mains gas and cMEV</b>	<b>Example B - Semi-detached heated by mains gas and NV with intermittent extract</b>	<b>Example C - Semi-detached heated by mains gas and MVHR</b>	<b>Example D - Semi-detached heated by heat pump and cMEV</b>	<b>Example E - Apartment heated by gas and MVHR</b>	<b>Example F - Apartment heated by heat pump and cMEV</b>
Primary energy [kWh/m <sup>2</sup> yr]	42	42	38	39	37	40
CO <sub>2</sub> emissions [kg/m <sup>2</sup> yr]	8	8	7	8	7	8
EPC	0.29	0.29	0.26	0.27	0.28	0.295
CPC	0.26	0.26	0.24	0.26	0.26	0.29
RER	0.24	0.26	0.22	0.39	0.23	0.34

# Appendix F

## Major renovations compliance examples

### Example 1:

**Semi-detached house (126 m<sup>2</sup>): hollow blocks walls with 25 mm mineral wool internal insulation, pitched roof with 50 mm mineral wool insulation on the ceiling, double glazing with 6 mm air gap, 80 % gas boiler installed with no heating controls, solid fuel stove secondary heating.**

Proposed works to elements <sup>1</sup>	Major renovation (Yes/No)	Required additional works
A) Window replacement (13 % of envelope)	No	NA
B) EWI or IWI of walls (35 % of envelope)	Yes	Upgrade insulation at ceiling level to 0.16 W/m <sup>2</sup> K or better as per table 5, and 90 % efficiency condensing gas boiler replacement and controls upgrade: time and temperature controls for space heating + time and temperature controls on domestic hot water
C) EWI or IWI of Walls and windows replacement (48 % of envelope)		
D) EWI or IWI of Walls and replacement of roof structure (61 % of envelope)		
E) EWI or IWI of Walls and replacement of floor (61 % of envelope)		

<sup>1</sup> Major Renovation of all elements should meet the requirements of Table 5 where material alteration applies.

**Primary energy consumption before major renovation: 233 kWh/m<sup>2</sup>/yr**

Proposed works package B) is based on the following specification: 100 mm EWI, 300 mm attic insulation, 91 % efficiency gas boiler, full zone time and temperature controls on space heating with weather compensation, time and temperature control on domestic hot water with insulated primary pipework.

**Primary energy consumption post major renovation: 121 kWh/m<sup>2</sup>/yr**



---

**Example 2:**

**Terraced house (96 m<sup>2</sup>): solid wall, pitched roof with 50 mm mineral wool insulation on the ceiling, double-glazing with 12 mm air gap and a U-value of 2.8 W/m<sup>2</sup>K, 68 % efficiency gas boiler installed with no control.**

Proposed works to elements <sup>1</sup>	Major renovation (Yes/No)	Additional works
A) Window replacement (15 % of envelope)	No	NA
B) EWI or IWI of walls (22 % of envelope)	No	NA
C) EWI or IWI of walls and ceiling insulation (53 % of envelope)	No <sup>2</sup>	NA
D) EWI or IWI of Walls and windows replacement (37 % of envelope)	Yes	Upgrade insulation at ceiling level to 0.16 W/m <sup>2</sup> K or better as per table 5, and 90 % efficiency condensing gas boiler replacement and controls upgrade: time and temperature controls for space heating + time and temperature controls on domestic hot water
E) EWI or IWI of Walls and replacement of roof structure (53 % of envelope)		
F) EWI or IWI of Walls and replacement of floor (53 % of envelope)		

<sup>1</sup> Major Renovation of all elements should meet the requirements of Table 5 where material alteration applies.

<sup>2</sup> Ceiling insulation is not replacement of the roof structure.

**Primary energy consumption before major renovation: 187 kWh/m<sup>2</sup>/yr**

Proposed works package D) is based on the following specification: 50 mm IWI, windows at 1.4 W/m<sup>2</sup>K, 300 mm attic insulation, 91 % efficiency gas boiler, time and temperature zone controls on space heating with weather compensation, time and temperature control on domestic hot water with insulated primary pipework.

**Primary energy consumption post major renovation: 107 kWh/m<sup>2</sup>/yr**

# Standards and publications

---

## Standards referred to:

I.S. 161:1975 Copper direct cylinders for domestic purposes

## [I.S. 10101:20XX National Rules for Electrical Installations](#)

I.S. EN 1745:2012 Masonry and masonry products - Methods for determining design thermal values

Eurocode 6 - Design of masonry structures (series)

I.S. EN 1996-1-1:2005 Eurocode 6 - Design of masonry structures – Part 1-1: Rules for reinforced and un-reinforced masonry

I.S. EN 1996-2:2006 Eurocode 6 - Design of masonry structures – Part 2: Design considerations, selection of materials and execution

I.S. EN 1996-3:2006 Eurocode 6 - Design of masonry structures – Part 3: Simplified calculations methods

I.S. EN 60531:2000 Household electric thermal storage room heaters – Methods for measuring performance

I.S. EN ISO 6946:2017 Building components and building elements – Thermal resistance and thermal transmittance – Calculation method

I.S. EN ISO 8990:1997 Thermal insulation – Determination of steady-state thermal transmission properties – Calibrated and guarded hot box

I.S. EN ISO 9972:2015 Thermal performance of buildings: determination of air permeability of buildings: fan pressurization method

I.S. EN ISO 10077-1:2006 Thermal performance of windows, doors and shutters – Calculation of thermal transmittance – Part 1: Simplified method

I.S. EN ISO 10077-2:2012 Thermal performance of windows, doors and shutters – Calculation of thermal transmittance – Part 2: Numerical methods for frames

I.S. EN ISO 10211:2007 Thermal bridges in building construction – Heat flows and surface temperatures – Detailed calculations

I.S. EN ISO 10456:2007 Building materials and products - Procedures for determining declared and design thermal values

I.S. EN ISO 12567-1:2010 Thermal performance of windows and doors – Determination of thermal transmittance by hot box method – Part 1: Complete windows and doors

I.S. EN 12631:2017 Thermal performance of curtain walling. Calculation of thermal transmittance

---

I.S. EN 13707:2013 Flexible sheets for waterproofing - Reinforced bitumen sheets for roof waterproofing - Definitions and characteristics

I.S. EN ISO 13370:2017 Thermal performance of buildings – Heat transfer via the ground – Calculation methods

I.S. EN ISO 13788:2012 Hygrothermal performance of building components and building elements - Internal surface temperature to avoid critical surface humidity and interstitial condensation - Calculation Methods (ISO 13788: 2001)

I.S. EN ISO 13789:2007 Thermal performance of buildings – Transmission heat loss coefficient – Calculation method

I.S. EN 15026:2007 Hygrothermal performance of building components and building elements – Assessment of moisture transfer by numerical simulation

I.S. EN 16883:2017 Conservation of cultural heritage – Guidelines for improving the energy performance of historic buildings

SR 50-2:2012 Code of practice for building services - Part 2: Solar panels

S.R. 54:2014 Code of practice for the energy efficient retrofit of dwellings

S.R. 325:2013 Recommendations for the design of masonry structures in Ireland to Eurocode 6 (+A1:2014)

BS 1566 Part 1:2002 Copper indirect cylinders for domestic purposes, open vented copper cylinders. Requirements and test methods

BS 5422:2009 Method for specifying thermal insulating materials for pipes, tanks, vessels, ductwork and equipment (operating within the temperature range – 40 °C to + 700 °C)

BS 8206 Part 2:2008 Lighting for buildings. Code of practice for daylighting

#### **Publications referred to:**

Advice Series, Energy Efficiency in Traditional Buildings, Department of the Environment, Heritage and Local Government 2010

Airtightness testing for new dwellings, A BSRIA Guide, Chris Knights and Nigel Potter, BSRIA 2006

BRE Digest 465, U-values for light steel frame construction, BRE 2002

BRE Good Building Guide 68 Part 2 Installing thermal insulation: Good site practice, BRE 2006

BRE Information Paper 1/06 Assessing the effects of thermal bridging at junctions and around openings, BRE 2001

BRE Information Paper 10/02, Metal cladding: assessing the thermal performance of built-up

---

systems using 'Z' spacers, BRE 2002

BRE Report BR 262, Thermal Insulation: avoiding risks, BRE 2001

BRE Report BR 364, Solar shading of buildings, BRE 1999

BRE Report BR 443, Conventions for U-value calculations, BRE 2006

BRE Report BR 497, Conventions for calculating linear thermal transmittance and temperature factors, BRE 2007

CIBSE Guide A: Environmental design - Section 3: Thermal properties of buildings and components, CIBSE 2006

CIBSE SLL Lighting Guide 10: Daylighting and window design, CIBSE 1999

CIBSE Manual AM 12: Combined Heat and Power in Buildings, CIBSE 2013

CIBSE TM 23: Testing buildings for air leakage, CIBSE 2000

CIBSE TM 37: Designing for improved solar shading control, CIBSE 2006

CIBSE TM 59: Design Methodology for the assessment of overheating risk in homes, CIBSE 2017

Domestic Energy Assessment Procedure (DEAP), SEAI 2006 ([www.seai.ie](http://www.seai.ie))

European Communities (Efficiency requirements for hot water boilers fired with liquid or gaseous fuels) Regulations 1994, S.I. No. 260 of 1994, Department of Transport, Energy and Communications 1994

Good Practice Guide 268, Energy efficient ventilation in dwellings – A guide for specifiers, 2006

Home-heating Appliance Register of Performance (HARP) database, SEAI ([www.seai.ie](http://www.seai.ie))

Heating and Domestic Hot Water Systems for Dwellings – Achieving compliance with Part L and Energy Performance of Buildings Regulations 2011 (to be published)

Limiting Thermal Bridging and Air Infiltration – Acceptable Construction Details (2011)

MCRMA Technical Paper No. 14, Guidance for the design of metal roofing and cladding to comply with Approved Document L2: 2001, The Metal Cladding and Roofing Manufacturers Association 2002

Planning Guidelines No. 9: Architectural Heritage Protection - Guidelines for Planning Authorities, Department of the Environment, Heritage and Local Government 2004

SCI Technical Information Sheet 312, Metal cladding: U-value calculation - Assessing thermal performance of built-up metal roof and wall cladding systems using rail and bracket spacers, The Steel Construction Institute 2002

---

Technical Standard L1, Measuring air permeability in the air envelopes of dwellings, ATTMA 2010

Window Energy Performance Certification Scheme (WEP), National Standards Authority of Ireland

# Other standards and publications

---

CE 82 Energy Efficiency Best Practice in Housing: Domestic ground source heat pumps: design and installation of closed loop system.

CIBSE Good practice in the design of homes TM60:2018

Design of low-temperature domestic heating systems – A guide for system designers and installers. FB 59. HIS BRE Press. Available from [www.brebookshop.com](http://www.brebookshop.com)

SEAI - Domestic solar photovoltaic – Code of practice for installers. Version 1.1, July 2018.

HVCA TR30 Guide to good practice: Heat pumps

I.S. EN 303-5: 1999 Heating boilers - Heating boilers for solid fuels, hand and automatically stoked, nominal heat output of up to 300 kw - Terminology requirements, testing and marking

I.S. EN 378-1:2016 Refrigerating systems and heat pumps. Safety and environmental requirements. Basic requirements, Definitions, classification and selection criteria.

I.S. EN 378-2:2016 Refrigerating systems and heat pumps. Safety and environmental requirements. Design, construction, testing, marking and documentation.

I.S. EN 378-3:2016 Refrigerating systems and heat pumps. Safety and environmental requirements. Installation site and personal protection.

I.S. EN 378-4:2016 Refrigerating systems and heat pumps. Safety and environmental requirements. Operation, maintenance, repair and recovery.

I.S. EN 12664: 2001 Thermal performance of building materials and products – Determination of thermal resistance by means of guarded hot plate and heat flow meters method – Dry and moist products of low and medium thermal resistance

I.S. EN 12667: 2001 Thermal performance of building materials and products – Determination of thermal resistance by means of guarded hot plate and heat flow meters method – Products of high and medium thermal resistance

I.S. EN 12975-1: 2006 Thermal solar systems and components - Solar collectors - Part 1: General requirements

I.S. EN 12828: 2003 Heating systems in buildings - Design for water-based heating systems

I.S. EN 12939: 2001 Thermal performance of building materials and products – Determination of thermal resistance by means of guarded hot plate and heat flow meters method – Thick products of high and medium thermal resistance

I.S. EN 12975-2: 2006 Thermal solar systems and components - Solar collectors - Part 2: Test methods

I.S. EN 12976-1: 2006 Thermal solar systems and components - Factory made systems - Part 1: General requirements

---

I.S. EN 12976-2: 2006 Thermal solar systems and components - Factory made systems - Part 2: Test methods

I.S. EN 14785: 2006 Residential space heating appliances fired by wood pellets - Requirements and test methods

I.S. EN 14511-1: 2018 Air conditioners, liquid chilling packages and heat pumps with electrically driven compressors for space heating and cooling - Part 1: Terms and definitions

I.S. EN 14511-2: 2018 Air conditioners, liquid chilling packages and heat pumps with electrically driven compressors for space heating and cooling - Part 2: Test conditions

I.S. EN 14511-3: 2018 Air conditioners, liquid chilling packages and heat pumps with electrically driven compressors for space heating and cooling - Part 3: Test methods

I.S. EN 14511-4: 2018 Air conditioners, liquid chilling packages and heat pumps with electrically driven compressors for space heating and cooling - Part 4: Requirements

I.S. EN 15270: 2007 Pellet burners for small heating boilers - Definitions, requirements, testing, marking

I.S. EN 15316-4-2: 2008 Heating systems in buildings: Methods for calculation of system energy requirements and system efficiencies. Space heating generation systems, Heat pump systems.

I.S. EN 15450: 2007 Heating systems in Buildings. Design of heat pump heating systems.

IS EN 12977-1: 2012 Thermal solar systems and components - Custom built systems - Part 1: General requirements

I.S. EN 12977-2: 2012 Thermal solar systems and components - Custom built systems - Part 2: Test methods

ISO 9806-1: 1994 Test methods for solar collectors - Part 1: Thermal performance of glazed liquid heating collectors including pressure drop

ISO 9806-2: 1995 Test methods for solar collectors - Part 2: Qualification test procedures

ISO 9806-3: 1995 Test methods for solar collectors - Part 3: Thermal performance of unglazed liquid heating collectors (sensible heat transfer only) including pressure drop

ISO 13256-1:1998 Water-source heat pumps. Testing and rating for performance. Water-to-air and brine-to-air heat pumps

ISO 13256-1:1998 Water-source heat pumps. Testing and rating for performance. Water-to-water and brine-to-water heat pumps

Microgeneration Certification Scheme standard MIS 3005 Requirements for contractors undertaking the supply, design, installation, set to work, commissioning, and handover of microgeneration heat pump systems





[housing.gov.ie](https://housing.gov.ie)

Department of Housing, Planning and Local Government



Rialtas na hÉireann  
Government of Ireland