



AQ No. 1368 for site T01/008A in Carlingford Lough, Co. Louth

The Licensee has been granted permission by the Minister under Section 67B of the Fisheries (Amendment) Act 1997 to use novel or experimental equipment in the form of Roll'Bags within the following co-ords:

320072,311720

320032,311738

of the licensed area covered by AQ No. 1368 for site T01/008A for the cultivation of Pacific Oysters in Carlingford Lough, Co. Louth for the remainder of the licence term.

In the event that the trial structures are no longer in use, they should be fully removed from site T01/008A.

DATE: 3rd August 2023

Tables drawings, every dimensions is in mm (1mm = 0.04 inch)

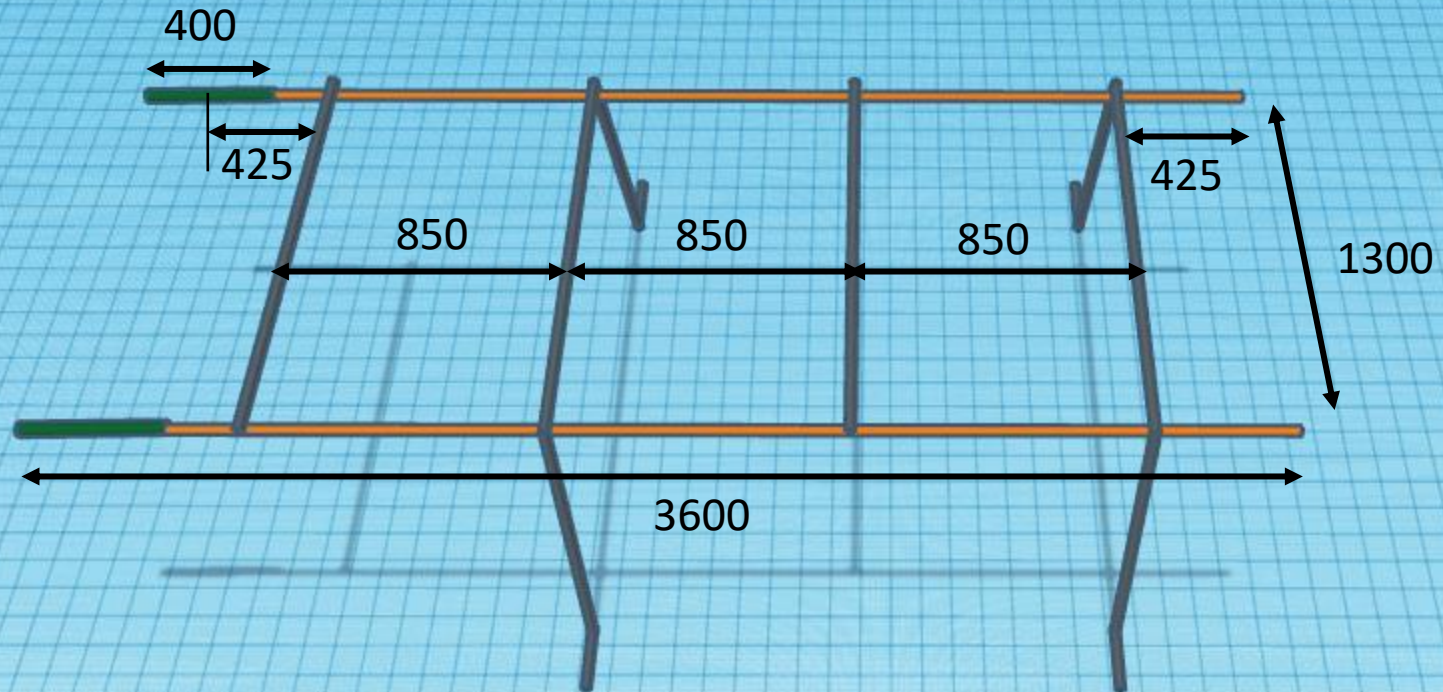

Tables drawings, every dimensions is in mm (1mm = 0.04 inch)

Every bar is 20mm diameter
crenelated steel which is hot
galvanised in France

400 mm length steel pipe, diameter
32mm. 200 mm are welded to the table
and other 200 mm will be used to nest
next table. Hot galvanised as well

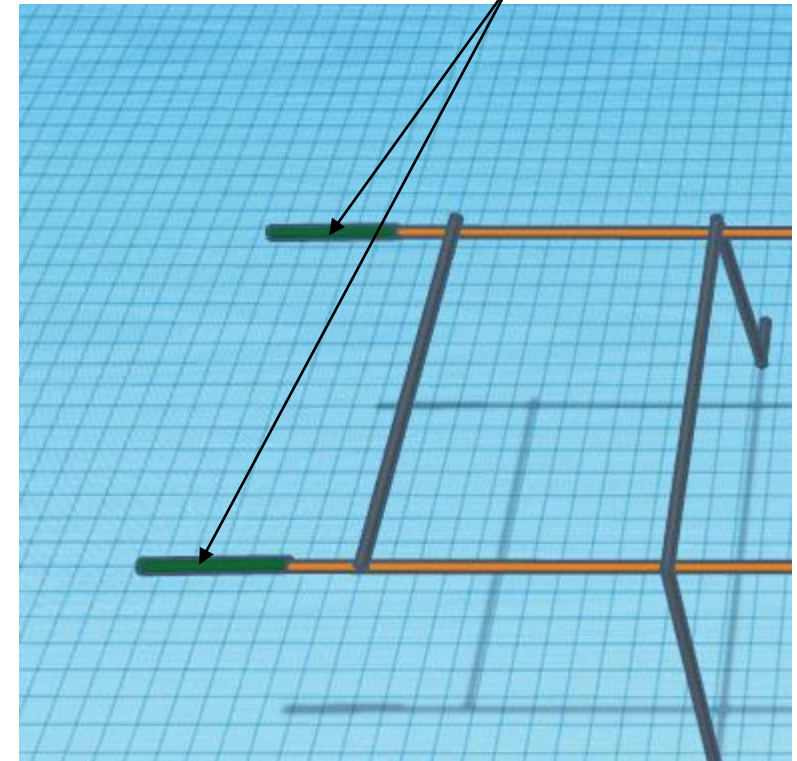
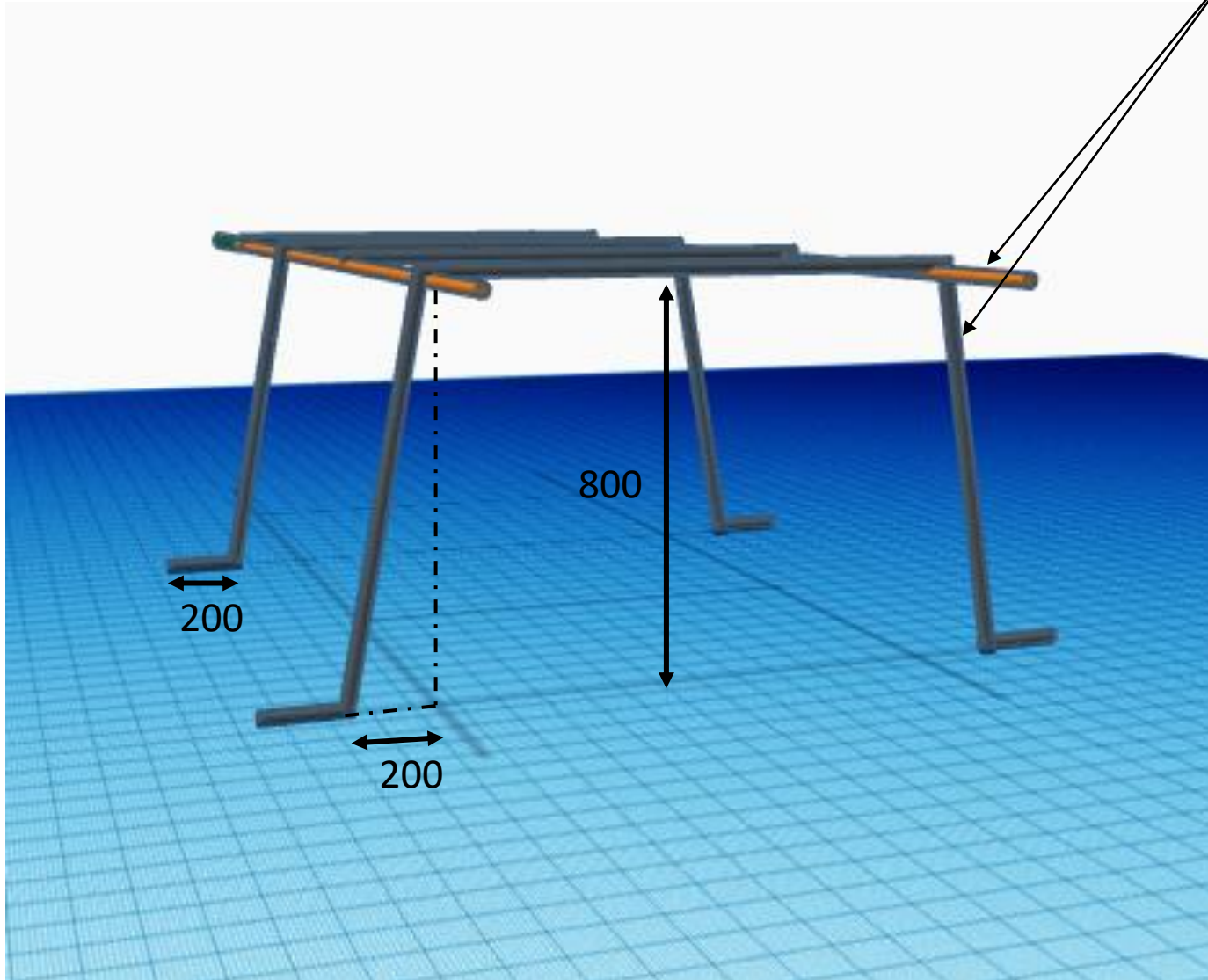

Roll'Bag® drawings, every dimensions is in mm (1mm = 0.04 inch)

A table is made to carry 4 Roll'Bags

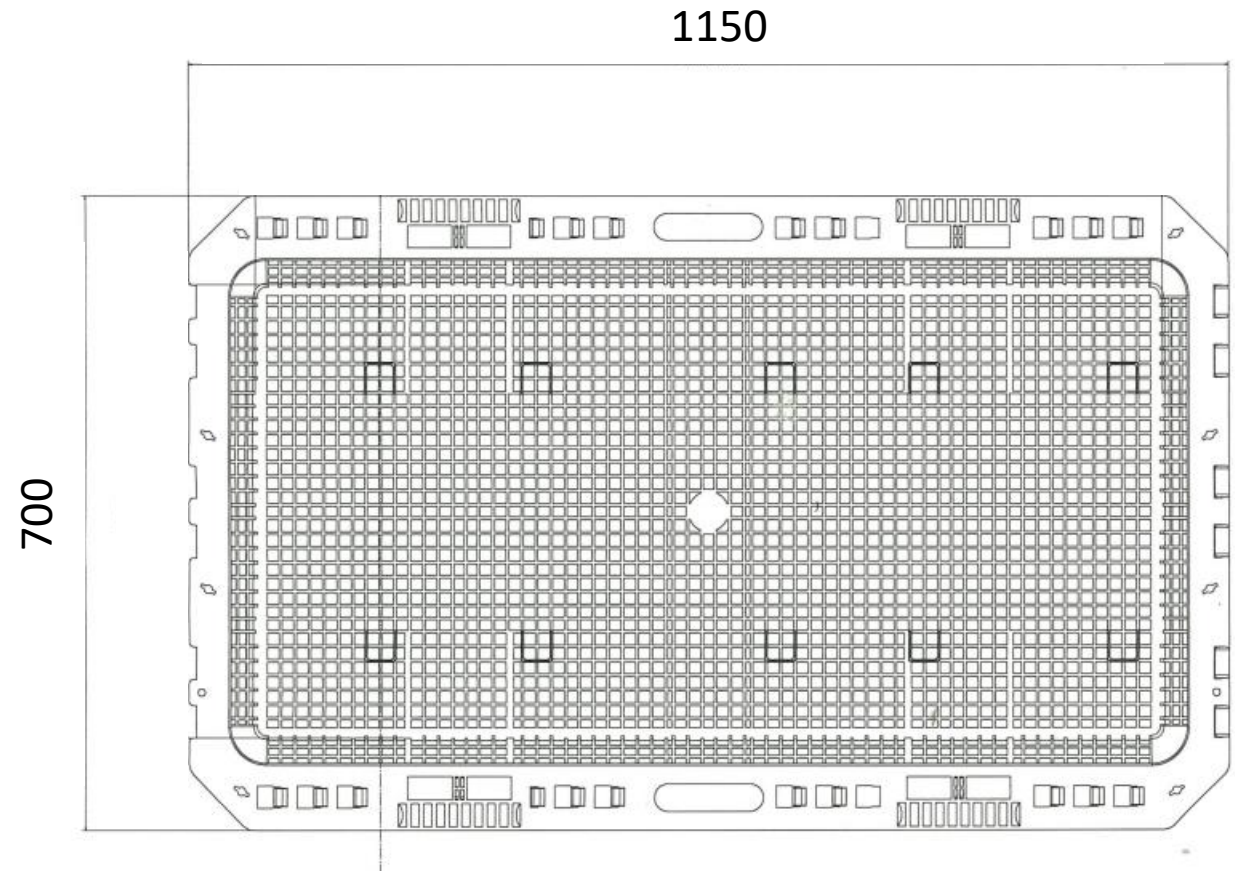

Some written informations :

A trestle is 3.4m long (+20cm for nesting), 1.3m large at the top, and approx. 80cm high, the trestle is made of 20mm diameter steel bars. 4 roll'bags can be put on one table.

A table weighs 45kg.

All tables are hot galvanized in order to increase their life span and avoid rust and steel wastes on the seashore after a few years.

A Roll'Bag is 115cm long, 70cm large and 12,5cm wide.

The volume inside is 40L but approx. 1/4 of the volume is used by the foam, which is locked inside to avoid any littering during bad weather. So its 30L for the oysters inside.

The foam volume is approx. 8L (it doesn't take the full 1/4 of the Roll'Bag) which can lift up to 21kg of oysters thanks to the tides (and waves).

Of course, 4 foams of 8L each, with oysters in the Roll'Bags, will not be able to lift the table itself.

Anyway we advise to seal tables in the ground since it is the only "weak point" of the system (hooks that hold Roll'Bags on the tables resist up to 1.5 T of traction).

"diabolos" (part sealed on the tables on which the Roll'Bag will be hooked) can be sealed on the table on land before deploying them on the seashore.



T01/008A

AQUACULTURE LICENCE

AQUACULTURE MARINE SHELLFISH
INTER/SUB-TIDAL
(Structures e.g. trestles)

Carlingford Oyster Company Limited
Mullatee
Carlingford
Co. Louth

TABLE OF CONTENTS

- 1. LICENSED AREA**
 - 2. SPECIES, CULTIVATION AND METHOD LICENSED**
 - 3. INFRASTRUCTURE AND SITE MANAGEMENT**
 - Indemnity*
 - Design, Arrangement and Maintenance of Structures*
 - Operational Conduct*
 - Waste Management*
 - Inspection*
 - 4. NAVIGATION AND SAFETY**
 - 5. MONITORING**
 - 6. FISH HEALTH / MORTALITY MANAGEMENT / MOVEMENT OF FISH**
 - Fish Health Regulations*
 - Disposal of Mortalities*
 - Movement of Fish*
 - 7. DURATION, CESSATION, REVIEW, REVOCATION, AMENDMENT, ASSIGNMENT**
 - Duration, Cessation*
 - Review*
 - Revocation, Amendment*
 - Assignment*
 - 8. FEES**
 - 9. GENERAL TERMS AND CONDITIONS**
 - Notification*
 - Tax Clearance Certificate*
 - Companies and Co-operatives*
 - Clearance of Site*
- SCHEDULE 1*
SCHEDULE 2
SCHEDULE 3
SCHEDULE 4

AQUACULTURE LICENCE NO. 1368

**GRANTED UNDER THE FISHERIES (AMENDMENT) ACT, 1997 (NO. 23 of
1997)**

The Minister for Agriculture, Food and the Marine (hereinafter referred to as the “Minister”), in exercise of the powers conferred on him by the Fisheries (Amendment) Act, 1997 (No. 23 of 1997) (hereinafter referred to as the “Act”), grants an Aquaculture Licence to:

Carlingford Oyster Company Limited

Mullatee

Carlingford

Co. Louth

(hereinafter referred to as the “Licensee”) for the cultivation of pacific oysters on a site in Carlingford Lough, Co. Louth as specified in Schedule 1 attached (numbered T01/008A) and indicated by a red line on the attached map in accordance with the plans and drawing(s) in Schedule 2 attached as approved of by the Minister, subject to the Act and Regulations made under the Act and to the terms and conditions set out in the attached pages.

This Aquaculture Licence shall remain in force for a maximum period of ten (10) years commencing on 20th January 2020, provided for so long as the Foreshore Licence granted on 20th January 2020, under Section 3(1) of the Foreshore Act 1933 (No.12 of 1933) in respect of the same site for the purpose referred to is in force.

A person authorised under Section 15(1)

of the Ministers and Secretaries Act 1924 to
authenticate the Seal of the Minister for
Agriculture, Food and the Marine.

TERMS AND CONDITIONS APPLYING TO THIS AQUACULTURE LICENCE

1. Licensed Area

- 1.1 The area specified in *Schedule 1* attached (4.14 hectares) (labelled T01/008A) and outlined in red on the map(s) in *Schedule 1*.
- 1.2 The co-ordinates for the site are based on the Irish National Grid Co-ordinate System.

2. Species, Cultivation and Method Licensed

- 2.1. Species to be farmed: Pacific Oysters (*Crassostrea Gigas*)
- 2.2. Method: Bags & Trestles, Floating Bags & Trestles and Baskets & Trestles subject to the stocking and/or deployment limits as may be specified in *Schedule 4* attached.
- 2.3. The introduction of seed to the site shall comply with the legislation relating to fish health.

3. Infrastructure and Site Management

Indemnity

- 3.1. The Licensee shall indemnify and keep indemnified the State, the Minister, his officers, servants or agents against all actions, loss, damage, costs, expenses and any demands or claims howsoever arising in connection with the construction, maintenance or use of any structures, apparatus, equipment or any other thing used in connection with the licensed operation in the licensed area or in the exercise of the rights granted under the licence and the Licensee shall take such steps as the Minister may specify in order to ensure compliance with this condition.
- 3.2. The duty of maintenance and responsibility for the upkeep and safety of the site rests with the Licensee.

Design, Arrangement and Maintenance of Structures

- 3.3. The Licensee shall ensure that the equipment (including all flotation, mooring and anchoring devices) is placed within the licensed area only. Storage or placement of equipment or stock on the foreshore or seashore outside the licensed area is not permitted under any circumstances.
- 3.4. The Minister may direct as to the deployment of apparatus and flotation devices and their colour, within the site.
- 3.5. The Licensee shall obtain the prior approval of the Minister to any proposed material change to the plan/drawings or equipment as approved being used during the licensing period as specified in *Schedule 2* attached.

- 3.6. The Licensee shall at all times for the duration of the licence keep all equipment used for the purposes of the licensed operations in a good and proper state of repair and condition to the satisfaction of the Minister or other competent State authority.
- 3.7. The Licensee shall ensure that each trestle grouping/pole and all flotation and mooring devices in the licensed area legibly bear the Aquaculture Licence Number in an indelible weatherproof format.

Operational Conduct

- 3.8. The Licensee shall conduct its operations in a safe manner and with regard for other persons in the area and the environment and shall ensure that the operations are not injurious to adjacent lands or the public interest (including the environment) and do not interfere with navigation or other lawful activity in the vicinity of the licensed area, and shall comply with any lawful directions issued by the Minister and any other competent State authority in that regard.
- 3.9. The Licensee shall ensure that any aquaculture or other activity conducted under this licence does not adversely affect the integrity of the Natura 2000 network (if applicable) through the deterioration of natural habitats and the habitats of species and/or through disturbance of the species for which the area has been designated in so far as such a disturbance may be significant in relation to the stated conservation objectives of the site concerned.
- 3.10. The Licensee shall ensure that tractors (or other vehicles) accessing and leaving the site adhere strictly to approved access and egress routes as specified in Schedule 1 attached. Full compliance is required in order to minimise disturbance to the foreshore and habitat. All drivers shall be made fully aware of the specific route approved.
- 3.11. The Licensee shall ensure that journeys back and forth on the approved access and egress routes are kept to the minimum necessary.
- 3.12. The Licensee shall ensure that all tractors/towing vehicles to be used for aquaculture purposes on the foreshore are fitted with efficient exhaust/silencers/mufflers and that vibration noise from tractors and machinery is kept to a minimum.
- 3.13. The Licensee shall ensure that all vehicles are properly maintained so as to prevent leakages of oils, fuels, grease etc.
- 3.14. The Licensee shall ensure that all vehicles move slowly at all times on the foreshore, that engine revolution is kept to a minimum and that engines are turned off when not in use.
- 3.15. The Licensee shall ensure that if more than one vehicle is needed on the shore that all vehicles, where possible, arrive and depart together.
- 3.16. The Licensee shall so organise its operations in consultation with other licensed operators to ensure that the total number of vehicles and harvesting machines on the foreshore on any one day is kept to the minimum necessary.

- 3.17. The Licensee shall ensure that when carrying out aquaculture work on the foreshore, dogs owned or under the control of the Licensee shall not be present, in order to minimise disturbance to the birdlife in the area.
- 3.18. The Licensee shall ensure that best practice is employed to keep structures and netting clean at all times and any biofouling by alien invasive species shall be removed and disposed of in a responsible manner. In particular, in 'Natura 2000' sites care must be taken to ensure that any biofouling by alien invasive species will not pose a risk to the conservation features of the site. Measures to be undertaken are set out in the draft Marine Code of Practice prepared by Invasive Species Ireland and can be found on the web site at: <http://invasivespeciesireland.com/>.

Waste Management

- 3.19. The Licensee shall ensure that the licensed and adjoining area shall be kept clear of all redundant structures (including apparatus, equipment and/or uncontained stock), waste products and operational litter or debris and shall make provision for the prompt removal and proper disposal of such material. If the Licensee refuses or fails to do so, the Minister may cause the said structures, apparatus, equipment or other thing to be removed and the licensed area restored and shall be entitled to recover from the Licensee as a simple contract debt in any court of competent jurisdiction all costs and expenses incurred by him in connection with the removal and restoration.

Inspection

- 3.20. The licensed area and any equipment, structure, thing, or premises wherever situated used in connection with operations carried out in the licensed area shall be open for inspection at any time by an authorised person (within the meaning of Section 292 of the Fisheries (Consolidation) Act 1959) (No. 14 of 1959) (as amended by Fisheries Act 1980) (No. 1 of 1980), a Sea Fisheries Protection Officer (within the meaning of Sea Fisheries and Maritime Jurisdiction Act 2006) (No. 8 of 2006) or any other person appointed in that regard by the Minister or other competent State authority.
- 3.21. The Licensee shall give all reasonable assistance to an authorised officer or a Sea Fisheries Protection Officer or any person duly appointed by any competent State authority to enable the person or officer enter, inspect, examine, measure and test the licensed area and any equipment, structure, thing or premises used in connection with the operations carried out in the licensed area and to take whatever samples may be deemed appropriate by that person or officer.
- 3.22. The Licensee shall keep and maintain in the State for inspection on demand by the Minister or a competent State authority, at all times, records of all operations including compliance monitoring and any required follow up action. These records shall be produced by the Licensee on demand by the Minister or other competent State authority and in any event not later than 24 hours from the making of that demand.
- 3.23. The Licensee shall furnish to the Minister or other competent State authority in the form and at the intervals determined by the Minister or other competent State

authority, such information relating to the licensed area as may be required to determine compliance by the Licensee with the terms of this licence and applicable legislation.

4. **Navigation and Safety**

- 4.1. The Licensee shall ensure that Statutory Sanction from the Commissioners of Irish Lights is in place prior to the commencement of operations, regarding all aids to navigation. Statutory Sanction forms are available at <http://www.cil.ie/safety-navigation/statutory-sanction.aspx>.
- 4.2. The Licensee shall ensure that the site is marked in accordance with the requirements of both the Marine Survey Office and the Commissioners of Irish Lights as specified in *Schedule 3*.
- 4.3. The Licensee shall comply with any specification requirement relating to navigational aids, flotation and mooring devices, supporting/marking posts/poles, as required by the Minister or any other competent State authority.
- 4.4. The Minister's determination in respect of this licence is conditional upon immediate full compliance by the Licensee in respect of all requirements and conditions which are imposed under the relevant legal provisions applicable to the Marine Survey Office.
- 4.5. Prior to commencement of operation the Licensee shall inform the UK Hydrographic Office at Taunton, of the location and nature of the site in order that charts and nautical publications can be updated. Tel: 00 44 1823337900 Fax: 00 44 1823 284077 Email: sdr@ukho.gov.uk the Licensee shall submit proof to the Department within 14 days of the date of this licence that the UK Hydrographic Office has been so informed.

5. **Monitoring**

- 5.1. The Licensee shall undertake and/or partake in monitoring, in particular environmental monitoring, as directed by the Minister or other competent State authority.

6. **Fish Health / Mortality Management / Movement of Fish**

Fish Health Regulations

- 6.1. Before the site is stocked the Licensee shall ensure that a Fish Health Authorisation under statutory provisions giving effect to Council Directive No. 2006/88/EC, as amended, or any other legislative act that replaces that Directive on animal health requirements for aquaculture animals and their products, and on the prevention and control of certain diseases in aquatic animals, is in place.

Disposal of Mortalities

- 6.2. The Licensee shall dispose of dead fish in accordance with the applicable statutory provisions and requirements.

Movement of Fish

6.3. The Licensee shall comply with any regulations in force governing the movement of fish.

7. Duration, Cessation, Review, Revocation, Amendment, Assignment

Duration, Cessation

7.1. This Licence shall remain in force until 19th January 2030 and as long as the accompanying Foreshore Licence remains in force.

Review

7.2. The Licensee may apply for a review of the licence at any time after the expiration of three years since the granting of the licence or its last renewal in accordance with section 70 of the Act.

Revocation, Amendment

7.3. Subject to the Act, the Minister may revoke or amend the licence if:–

- (a) he considers that it is in the public interest to do so;
- (b) he is satisfied that there has been a breach of any condition specified in the licence, e.g. operating outside the licensed area;
- (c) the licensed area to which the licence relates is not being properly maintained;
- (d) water quality results or general performance in the licensed area do not meet the standards set by the Minister or the competent State authority.

Assignment

7.4. This Licence shall not be assigned without the prior written consent of the Minister and may not be assigned during the period of three years, dating from the commencement or renewal of this licence, unless the Minister determines that it may be assigned under condition 7(5) or the condition set out in 7(6) applies.

7.5. A Licensee, who considers that there are exceptional reasons for the assignment of the Licence during the first three years, may apply to the Minister, giving those reasons, for a determination that the Licence may be assigned. The Minister may, at his discretion, having considered the reasons given by the Licensee, determine whether or not the Licence may be assigned. The determination of the Minister in this regard is final.

7.6. Where the Licensee is a company (within the meaning of the Companies Acts) and goes into Liquidation (within the meaning of the Companies Acts) in the first three years dating from the commencement of the licence, the Liquidator shall, with the consent of the Minister, be entitled to assign the licence to enable him to discharge any debts of the liquidated company.

7.7. This licence is issued subject to any order that the High Court may make under section 218 of the Companies Act 1963 or otherwise with regard to the assignment of this licence.

8. **Fees**

- 8.1. The Licensee shall pay to the Minister an annual aquaculture licence fee in accordance with the Aquaculture (Licence Application and Licence Fees) Regulations 1998(S.I. No. 270/1998) as amended by the Aquaculture (Licence Fees) Regulations 2000 (S.I. No. 282 of 2000) or an amount payable under Regulations made under section 64 of the Act.
- 8.2. The Minister may revoke the licence where the Licensee fails to pay the aquaculture licence fees on demand.

9. **General Terms and Conditions**

- 9.1. The Licensee shall at all times comply with all laws and protocols applicable to aquaculture operations.
- 9.2. Any reference to a statute or an act of an institution of the European Union (whether specifically named or not) includes any amendments or re-enactments in force and all statutory instruments, orders, notices, regulations, directions, bye-laws, certificates, permissions and plans made, issued or given effect under such legislation shall remain valid.
- 9.3. If any condition or part of a condition in this licence is held to be illegal or unenforceable in whole or in part, such condition shall be deemed not to form part of this licence but the enforceability of the remainder of this licence is not affected.
- 9.4. The Licensee shall at all times hold all necessary licences, consents, permissions, permits or authorisations associated with any activities of the Licensee in connection with the licensed area.

Notification

- 9.5. Without prejudice to any other remedy under the licence or in law, if the Minister is of the view that the Licensee is in breach of any obligation under this licence, the Minister may, by notice in writing, require that the Licensee rectifies such breach, within such time as is specified by the Minister. The Licensee shall comply with any direction of the Minister within the time specified in the notice.
- 9.6. Any notice to be given by the Minister may be transmitted through the Post Office addressed to the Licensee at the last known address of the Licensee.
- 9.7. The Licensee shall notify the Minister within 7 days of any change in the Licensee's address, telephone, e-mail or facsimile number.

Tax Clearance Certificate

- 9.8. During the term of this licence the Licensee shall provide to the Minister on demand a current tax clearance certificate.

Companies and Co-operatives

- 9.9. In the event of the licence being granted to a company (within the meaning of the Companies Acts), control of the licensee company shall not change in any respect

from the control of the company as existed on the date that the licence was granted so long as this licence shall remain in force save with the prior written permission of the Minister.

- 9.10. In the event of a licence being granted to a company that has been incorporated outside this State, the licensee company shall register with the Companies Registration Office within one month of the establishment of a place of business in the State or alternatively, within one month of the establishment of a branch of the said company in the State and the licensee company shall submit proof to the Department within 14 days of the end of that month that it has been so registered.
- 9.11. Where the licensee is a company within the meaning of the Companies Acts, the licensee company shall ensure that it does not become dissolved within the meaning of the Companies Acts for so long as this licence shall remain in force.
- 9.12. In the event of the licence being granted to a society (within the meaning of section 2 of the Industrial and Provident Societies (Amendment) Act 1978 (No.23 of 1978) the following conditions shall apply:-
- 9.12.1 The rules relating to membership of the society shall enable any resident of the State to become a member of it where the resident fulfils all the conditions laid down by the society for membership of it and the rules shall not lay down different conditions for different classes of people;
- 9.12.2 The rules relating to the society as submitted to the Minister before the grant of this licence shall not be amended subsequently other than with the written permission of the Minister; and
- 9.12.3 The Minister may, if he considers it necessary in the interests of good management of the licensed area, direct that an amendment may be made to the rules of the society, and the Licensee shall amend the rules in accordance with that direction.

Clearance of Site

- 9.13. The Licensee shall, at the Licensee's own expense, if so required by written notice from the Minister and within three weeks after receipt of such notice or on cessation of the licence for any other cause, remove the structures, apparatus, equipment or any other thing to the satisfaction of the Minister. If the Licensee refuses or fails to do so, the Minister may cause the said structures, apparatus, equipment or other thing to be removed and the licensed area restored and shall be entitled to recover from the Licensee as a simple contract debt in any court of competent jurisdiction all costs and expenses incurred by him in connection with the removal and restoration. The Licensee shall take such steps as the Minister may specify in order to secure compliance with this condition.

SCHEDULE 1

Schedule 1 contains:

- the co-ordinates of the site based on the Irish National Grid Co-ordinate System and the area of the site
- site map(s) which also shows the access/egress route to and from the site
- a chart showing the location of the site in relation to the surrounding area.

1 NO. SITE AT CARLINGFORD LOUGH CO.LOUTH

Co-ordinates & Area

Site T01/008A (4.14 Ha)

The area seaward of the high water mark and enclosed by a line drawn from Irish National Grid Reference point

320032, 311738 to Irish National Grid Reference point
320092, 311820 to Irish National Grid Reference point
320410, 311590 to Irish National Grid Reference point
320350, 311500 to the first mentioned point.

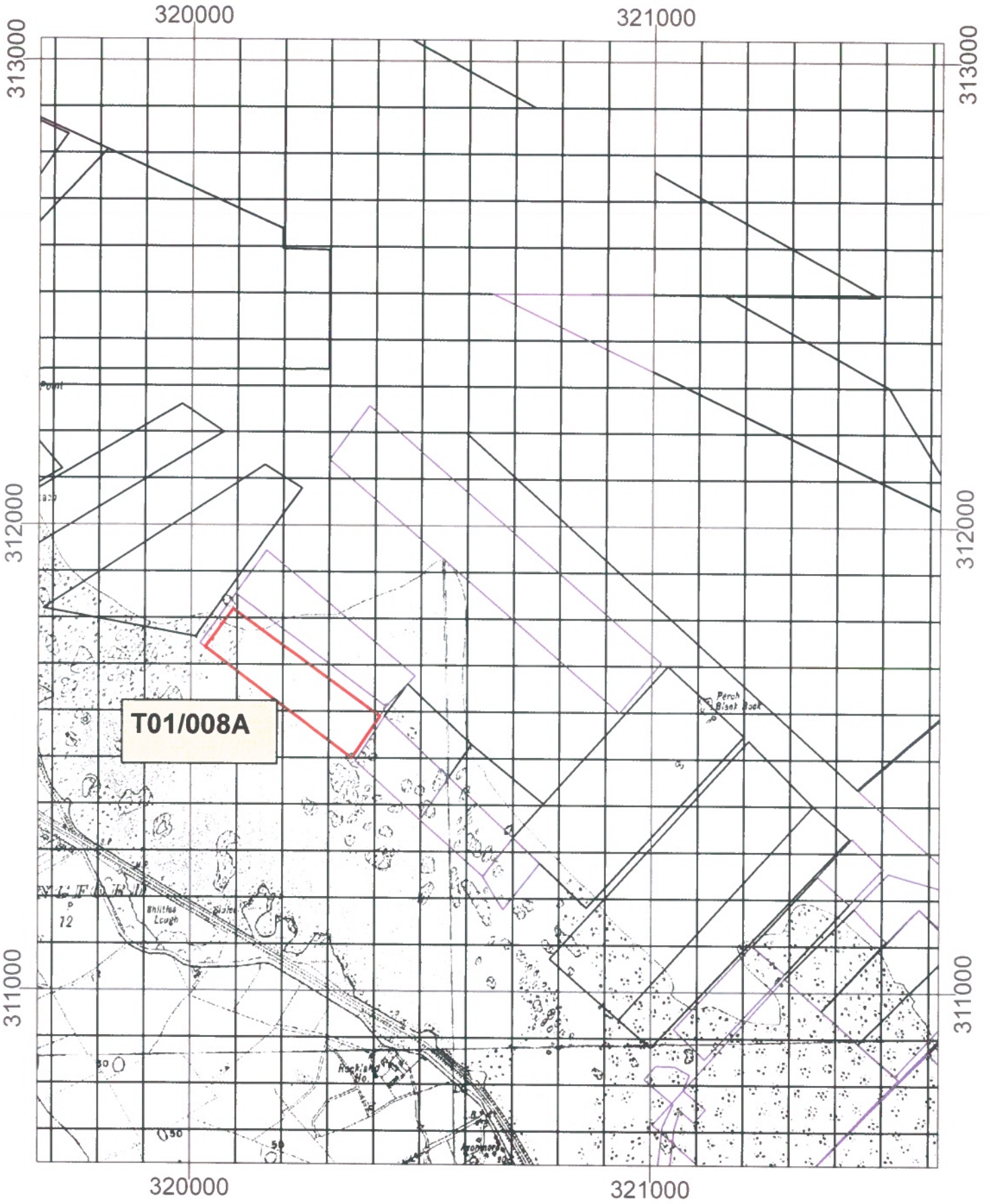

Aqua Culture Sites

<all other values>

Site_Status

- Under Appeal
- Application
- Lapsed
- Licensed
- Refused
- Revoked
- Surrendered
- Withdrawn
- 100 Meter Reference Grid

1:10,560

Sites highlighted in red denotes Application

Ordnance Survey Ireland Licence No. EN 0076418
© Ordnance Survey Ireland/Government of Ireland



**An Roinn Talmhaíochta,
Bia agus Mara**
Department of Agriculture,
Food and the Marine

SCHEDULE 2

Schedule 2 contains:

- the approved plans and drawing(s)

Carlingford lough



Carlingford

LOCATION OF SITE
REF. No. T01/008A

ACCESS ROUTE
TO SITE

Greenore

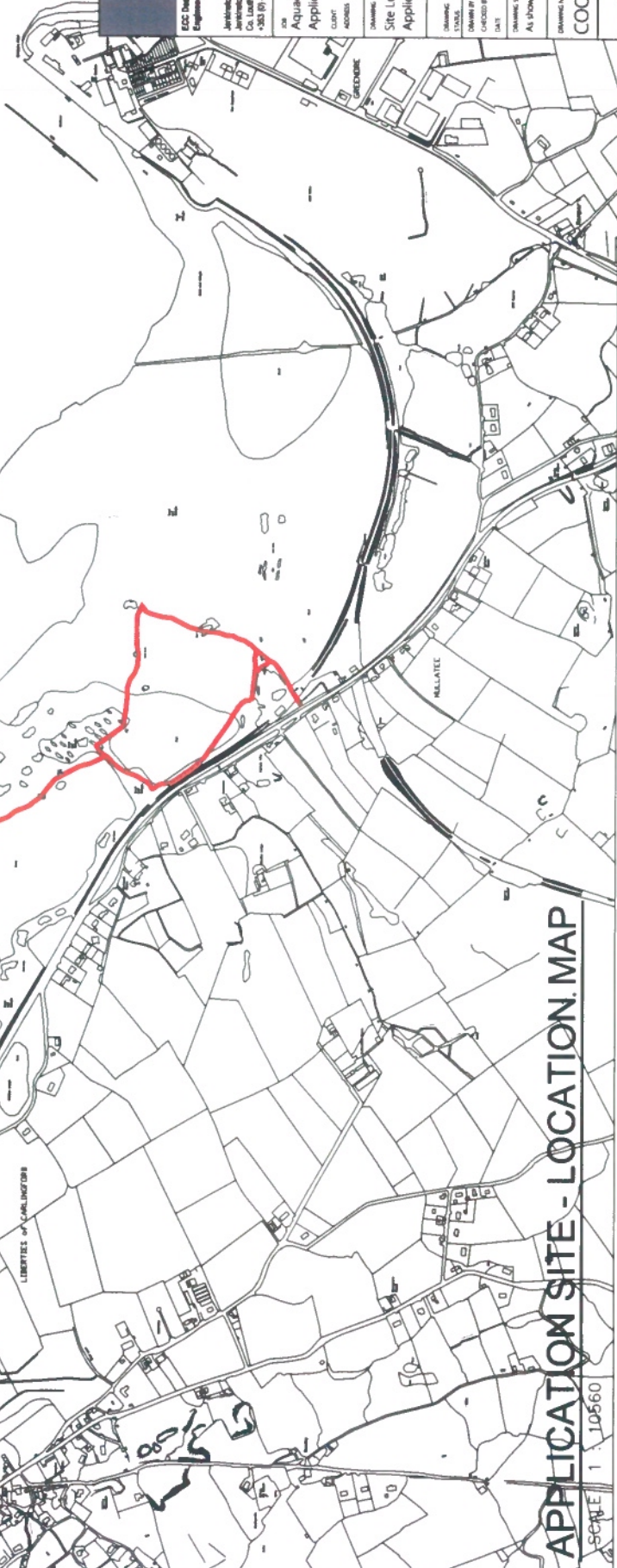

ECC	
ECC Design & Engineering Limited	
Aniridhavan Boman Park, Junction 10, Dunshaughlin, Co. Louth, Ireland, M11 W22A www.eccgroup.ie info@eccgroup.ie	
004	
Aquaculture & Foreshore Licence Application at Carlingford Lough	
CLIENT:	Carlingford Oyster Company
ADDRESS:	Carlingford Lough, Co. Louth
DRAWING TITLE	
Site Location Map	
Application No. T01/008A	
DRAWING STATUS:	LOOSE DRAWING
DRAWN BY:	Colin Holmes
CHECKED BY:	Colin Holmes
DATE:	April 2019
DRAWING SCALE:	As Shown
DRAWING NUMBER:	COC1 - 001.
REVISION:	-

APPLICATION SITE - LOCATION MAP
SCALE 1:10560



Carlingford Lough

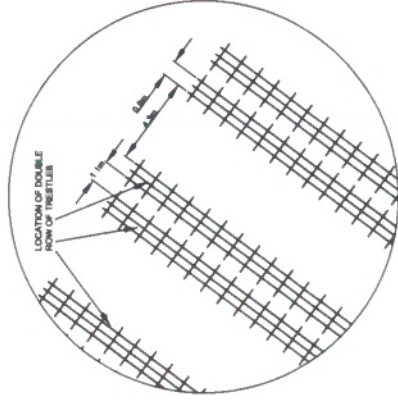

LAYOUT PLAN OF TRESTLES
SCALE 1 : 250

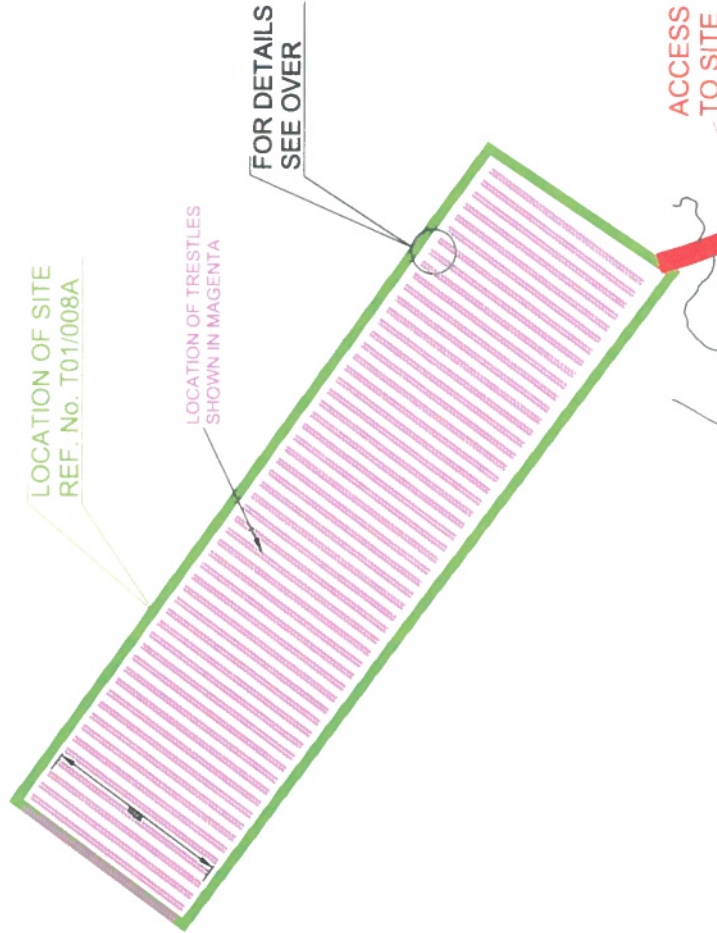

LOCATION OF SITE
REF. No. T01/008A

LOCATION OF TRESTLES
SHOWN IN MAGENTA

FOR DETAILS
SEE OVER

ACCESS ROUTE
TO SITE

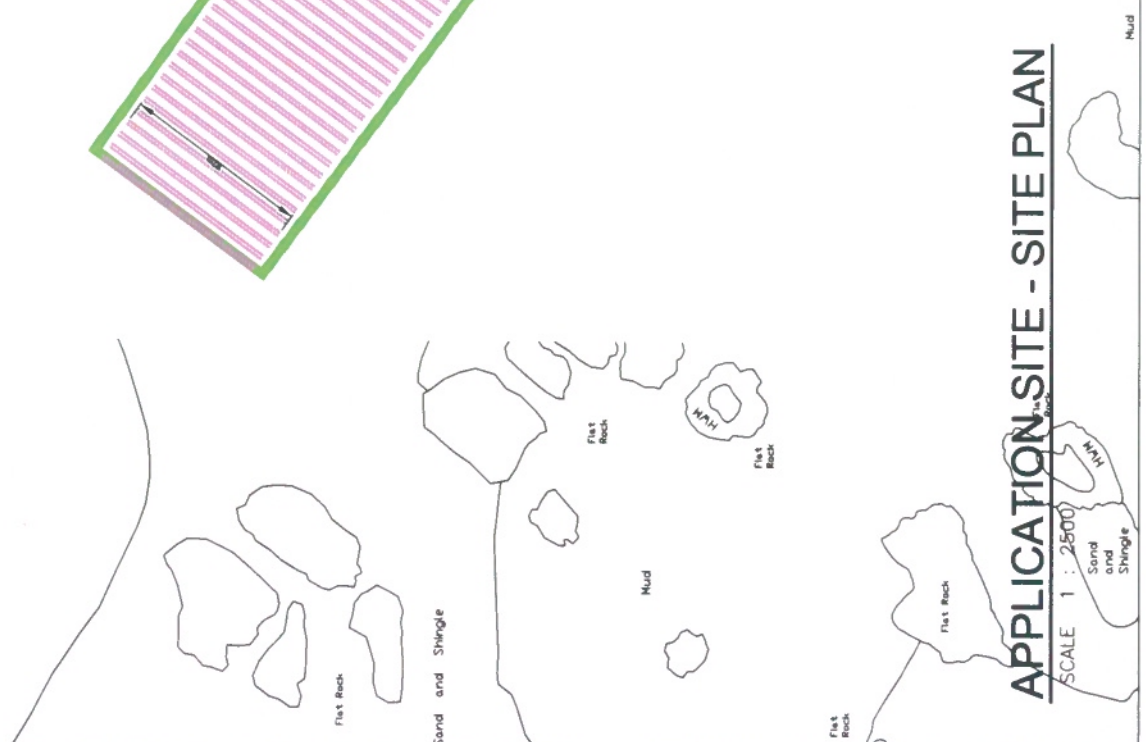

APPLICATION SITE - SITE PLAN

SCALE 1 : 2500

Sand and Shingle

Mud

ECC	
ECC Design & Engineering Limited	
Jerrington Business Park Jerrington, Drogheda, Co. Louth, Ireland +353 (0) 42 208 2000	www.eccgroup.ie info@eccgroup.ie
or Aquaculture & Foreshore Licence Application at Carlingford Lough	
CLIENT: Carlingford Oyster Company	
ADDRESS: Carlingford Lough, Co. Louth	
DRAWING TITLE: Site Layout Plan Application No. T01/008A	
DRAWING STATUS: License drawing	
DRAWN BY: Colin Holmes	
CHECKED BY: Colin Holmes	
DATE: April 2018	
DRAWING SCALE: As shown	
DRAWING NUMBER: COC1 - 002	REVISION: -

701/008A

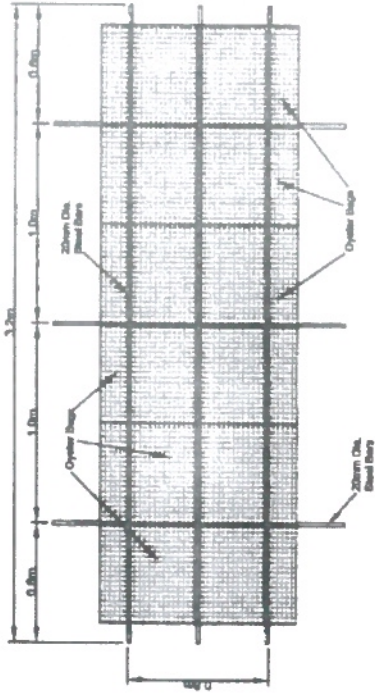

PLAN - 6 bags on each treble
SCALE 1 : 25

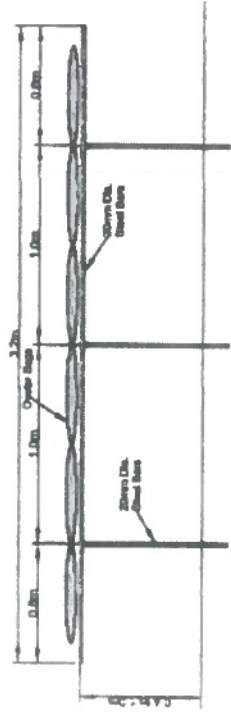

LONGITUDINAL SECTION
SCALE 1 : 25

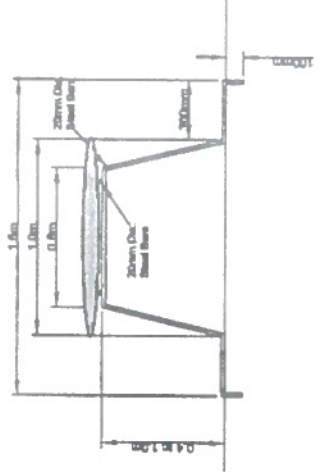

CROSS SECTION
SCALE 1 : 25

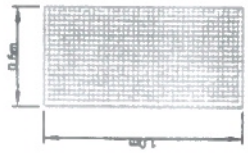

TYPICAL OYSTER BAG
SCALE 1 : 25

ECC	
ECC Group & Engineering Limited	www.eccgroup.co.uk
Industrial Business Park	www.eccgroup.co.uk
Ammanford, South	info@eccgroup.co.uk
Co. Louth, Ireland, CF11 1YD	
+353 (0) 47 838 2000	
Professional Services	
Structural & Forensic Licence	Application at Carlingford Lough
Member	Engineer
Company Name	Company Name
Company No.	Company No.
Company Address	Company Address
Company City	Company City
Company State	Company State
Company Postcode	Company Postcode
Company Email	Company Email
Company Phone	Company Phone
Company Fax	Company Fax
Company Website	Company Website
Company Logo	Company Logo
Company Reference	Company Reference
Company Notes	Company Notes
Company Comments	Company Comments
Company Status	Company Status
Company Type	Company Type
Company Category	Company Category
Company Subcategory	Company Subcategory
Company Subcategory 2	Company Subcategory 2
Company Subcategory 3	Company Subcategory 3
Company Subcategory 4	Company Subcategory 4
Company Subcategory 5	Company Subcategory 5
Company Subcategory 6	Company Subcategory 6
Company Subcategory 7	Company Subcategory 7
Company Subcategory 8	Company Subcategory 8
Company Subcategory 9	Company Subcategory 9
Company Subcategory 10	Company Subcategory 10
Company Subcategory 11	Company Subcategory 11
Company Subcategory 12	Company Subcategory 12
Company Subcategory 13	Company Subcategory 13
Company Subcategory 14	Company Subcategory 14
Company Subcategory 15	Company Subcategory 15
Company Subcategory 16	Company Subcategory 16
Company Subcategory 17	Company Subcategory 17
Company Subcategory 18	Company Subcategory 18
Company Subcategory 19	Company Subcategory 19
Company Subcategory 20	Company Subcategory 20
Company Subcategory 21	Company Subcategory 21
Company Subcategory 22	Company Subcategory 22
Company Subcategory 23	Company Subcategory 23
Company Subcategory 24	Company Subcategory 24
Company Subcategory 25	Company Subcategory 25
Company Subcategory 26	Company Subcategory 26
Company Subcategory 27	Company Subcategory 27
Company Subcategory 28	Company Subcategory 28
Company Subcategory 29	Company Subcategory 29
Company Subcategory 30	Company Subcategory 30
Company Subcategory 31	Company Subcategory 31
Company Subcategory 32	Company Subcategory 32
Company Subcategory 33	Company Subcategory 33
Company Subcategory 34	Company Subcategory 34
Company Subcategory 35	Company Subcategory 35
Company Subcategory 36	Company Subcategory 36
Company Subcategory 37	Company Subcategory 37
Company Subcategory 38	Company Subcategory 38
Company Subcategory 39	Company Subcategory 39
Company Subcategory 40	Company Subcategory 40
Company Subcategory 41	Company Subcategory 41
Company Subcategory 42	Company Subcategory 42
Company Subcategory 43	Company Subcategory 43
Company Subcategory 44	Company Subcategory 44
Company Subcategory 45	Company Subcategory 45
Company Subcategory 46	Company Subcategory 46
Company Subcategory 47	Company Subcategory 47
Company Subcategory 48	Company Subcategory 48
Company Subcategory 49	Company Subcategory 49
Company Subcategory 50	Company Subcategory 50
Company Subcategory 51	Company Subcategory 51
Company Subcategory 52	Company Subcategory 52
Company Subcategory 53	Company Subcategory 53
Company Subcategory 54	Company Subcategory 54
Company Subcategory 55	Company Subcategory 55
Company Subcategory 56	Company Subcategory 56
Company Subcategory 57	Company Subcategory 57
Company Subcategory 58	Company Subcategory 58
Company Subcategory 59	Company Subcategory 59
Company Subcategory 60	Company Subcategory 60
Company Subcategory 61	Company Subcategory 61
Company Subcategory 62	Company Subcategory 62
Company Subcategory 63	Company Subcategory 63
Company Subcategory 64	Company Subcategory 64
Company Subcategory 65	Company Subcategory 65
Company Subcategory 66	Company Subcategory 66
Company Subcategory 67	Company Subcategory 67
Company Subcategory 68	Company Subcategory 68
Company Subcategory 69	Company Subcategory 69
Company Subcategory 70	Company Subcategory 70
Company Subcategory 71	Company Subcategory 71
Company Subcategory 72	Company Subcategory 72
Company Subcategory 73	Company Subcategory 73
Company Subcategory 74	Company Subcategory 74
Company Subcategory 75	Company Subcategory 75
Company Subcategory 76	Company Subcategory 76
Company Subcategory 77	Company Subcategory 77
Company Subcategory 78	Company Subcategory 78
Company Subcategory 79	Company Subcategory 79
Company Subcategory 80	Company Subcategory 80
Company Subcategory 81	Company Subcategory 81
Company Subcategory 82	Company Subcategory 82
Company Subcategory 83	Company Subcategory 83
Company Subcategory 84	Company Subcategory 84
Company Subcategory 85	Company Subcategory 85
Company Subcategory 86	Company Subcategory 86
Company Subcategory 87	Company Subcategory 87
Company Subcategory 88	Company Subcategory 88
Company Subcategory 89	Company Subcategory 89
Company Subcategory 90	Company Subcategory 90
Company Subcategory 91	Company Subcategory 91
Company Subcategory 92	Company Subcategory 92
Company Subcategory 93	Company Subcategory 93
Company Subcategory 94	Company Subcategory 94
Company Subcategory 95	Company Subcategory 95
Company Subcategory 96	Company Subcategory 96
Company Subcategory 97	Company Subcategory 97
Company Subcategory 98	Company Subcategory 98
Company Subcategory 99	Company Subcategory 99
Company Subcategory 100	Company Subcategory 100

DETAILS OF STANDARD TRESTLE

COC - 003

Td/0084

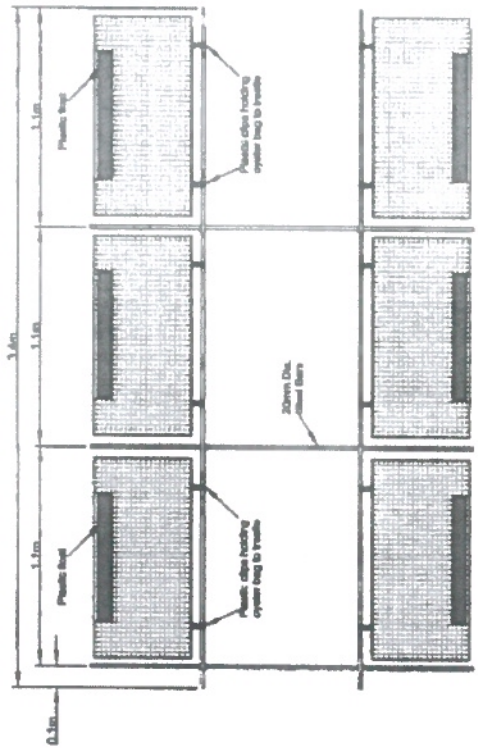

PLAN - 6 bags fitted to each trellis
SCALE 1 : 25

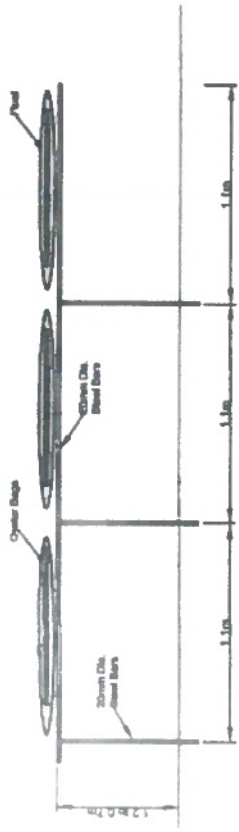

LONGITUDINAL SECTION
SCALE 1 : 25

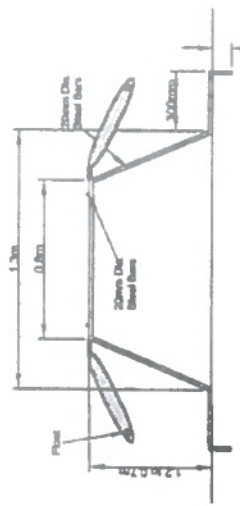

CROSS SECTION
SCALE 1 : 25

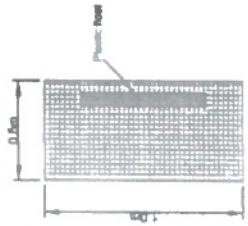

TYPICAL OYSTER BAG
SCALE 1 : 25

ECC	
ECC Design & Engineering Limited	www.eccdesign.co.uk
Administrative Business Park Cott Lane, Loughborough Leicestershire LE11 1BB	01509 203000
at Aquaculture & Foreshore Licence Application at Carrington Lough	
client Carrington Oyster Company Carrington Lough, Co. Louth	project No. Details of Trellis Drawing 1 of 3
contract ref. L10000000	contract date 10th Feb 2010
contract ref. COC-001	contract date April 2010
contract ref. As Above	contract date As Above
contract ref. COC - 001	contract date -

DETAILS OF FLOATING BAG TRELLIS

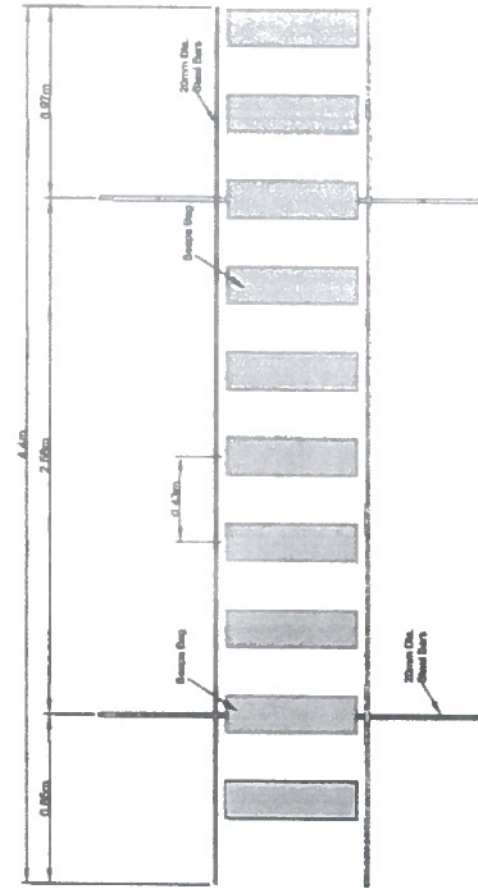

PLAN
SCALE 1 : 25

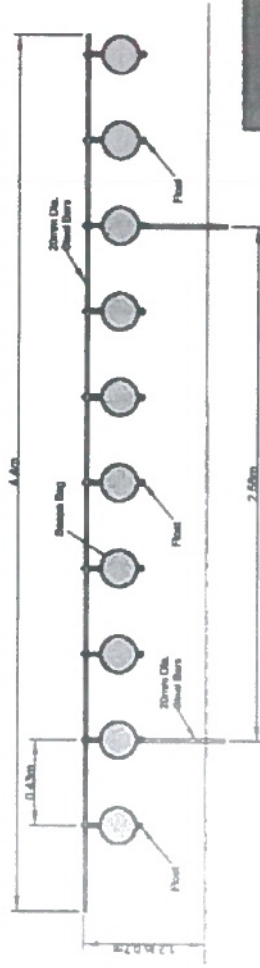

LONGITUDINAL SECTION
SCALE 1 : 25

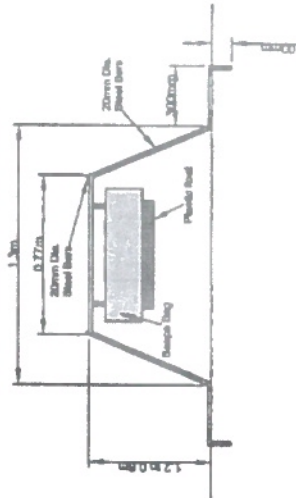

CROSS SECTION
SCALE 1 : 25

ECC	
ECC Design & Engineering Limited	
100, 101, 102, 103, 104, 105, 106, 107, 108, 109, 110, 111, 112, 113, 114, 115, 116, 117, 118, 119, 120, 121, 122, 123, 124, 125, 126, 127, 128, 129, 130, 131, 132, 133, 134, 135, 136, 137, 138, 139, 140, 141, 142, 143, 144, 145, 146, 147, 148, 149, 150, 151, 152, 153, 154, 155, 156, 157, 158, 159, 160, 161, 162, 163, 164, 165, 166, 167, 168, 169, 170, 171, 172, 173, 174, 175, 176, 177, 178, 179, 180, 181, 182, 183, 184, 185, 186, 187, 188, 189, 190, 191, 192, 193, 194, 195, 196, 197, 198, 199, 200	
at Aquaculture & Foreshore Licence Application at Carrigford Lough	
client	Carraigead Ógair Company Carraigead Lough, Co. Louth
contract no.	
Details of Trestles Drawing 2 of 3	
designer (scale)	License Drawing
checked by	Clara McNamee
drawn by	Clara McNamee
date	April 2019
contract name	As Above
contract no.	
drawing no.	COC - 002

DETAILS OF SEAPA BAG TRESTLE

701/0084

SCHEDULE 3

Schedule 3 contains:

- The site shall be marked in accordance with the requirements of the Special Unified Marking Scheme (SUMS) within Carlingford Lough.

SCHEDULE 4

Schedule 4 contains conditions specific to this licence:

- The Licensee shall ensure that the initial source of seed and any subsequent seed sources be approved by the Department of Agriculture, Food and the Marine.
- The Licensee shall, prior to the commencement of operations, draw up a Contingency Plan, for the approval of the Department of Agriculture, Food and the Marine which will identify methods for the removal from the environment of any invasive non-native species introduced as a result of operations from the site. If such an event occurs, the Contingency Plan shall be implemented immediately.
- The access route over the intertidal habitat must be strictly adhered to, in order to minimise habitat disturbance.



T01/008A

FORESHORE LICENCE

Carlingford Oyster Company Limited

Mullatee

Carlingford

Co. Louth

TABLE OF CONTENTS

TERMS AND CONDITIONS APPLICABLE TO FORESHORE LICENCE

SEAL OF OFFICE AND SIGNATURES

SCHEDULE 1

FORESHORE LICENCE IN RESPECT OF A SITE
(NUMBERED T01/008A) AT CARLINGFORD LOUGH, CO. LOUTH

AGREEMENT made on the 20th January 2020, between the Minister for Agriculture, Food and the Marine (hereinafter referred to as the “Minister” which expression shall include his Successors or Assigns where the contract so requires or admits), of the one part, and

Carlingford Oyster Company Limited

Mullatee

Carlingford

Co. Louth

(hereinafter referred to as the “Licensee”) of the other part, whereby the Minister, in exercise of the powers conferred on him by Section 3 of the Foreshore Act, 1933 (No.12 of 1933) hereby grants to the Licensee licence to use and occupy that part of the foreshore at Carlingford Lough, Co Louth (numbered T01/008A) detailed in the attached schedule and more particularly delineated on the map annexed hereto and thereon coloured red for the purpose of the cultivation set out in Aquaculture Licence Number 1368 on the terms and conditions set out in the attached pages.

This Foreshore Licence shall remain in force for a maximum period of ten (10) years commencing on 20th January 2020, provided for so long as the Aquaculture Licence Number 1368 granted on 20th January 2020 under the Fisheries (Amendment) Act 1997 (No. 23 of 1997) in respect of the same site for the purpose referred to is in force.

TERMS AND CONDITIONS APPLICABLE TO FORESHORE LICENCE

1. The Licensee shall pay to the Minister the annual sum of €63.49 (sixty three euro forty nine cent), such payment to be made on the 20th day of January in every year during the continuance of this Licence, the first of such payments to be made on the signing hereof.
2. The Licensee shall use that part of the foreshore, the subject matter of this Licence, for the cultivation set out in Aquaculture Licence Number 1368 only and for no other purpose whatsoever.
3. The Licensee shall comply fully with all terms and conditions of Aquaculture Licence Number 1368.
4. The Licensee shall indemnify and keep indemnified the State, the Minister, his officers, servants or agents against all actions, loss, damage, costs, expenses and any demands or claims however arising in connection with the construction, maintenance or use of any structures, apparatus, equipment or any other thing used in connection with the licensed operation in the licensed area or in the exercise of the rights granted under the licence and the Licensee shall take such steps as the Minister may specify in order to ensure compliance with this condition.
5. The duty of maintenance and responsibility for the upkeep and safety of the site rests with the Licensee.
6. The Minister shall be at liberty at any time to terminate this Licence by giving to the Licensee three months notice in writing ending on any day, and upon determination of such notice, the Licence and permission granted shall be deemed to be revoked and withdrawn without the liability for the payment of any compensation by the Minister to the Licensee.
7. Any notice to be given by the Minister may be transmitted through the Post Office addressed to the Licensee at the last known address of the Licensee.
8. The Licensee shall not carry out any operations authorised by the Licence in the licensed area in such a manner as to interfere unreasonably with fishing or navigation in the vicinity of the licensed area and shall comply with any direction given to the Licensee in that regard by the Minister.
9. In the event of the breach, non-performance or non-observance by the Licensee of any of the conditions herein contained, the Minister may forthwith terminate this Licence without prior notice to the Licensee.

AND IT IS HEREBY CERTIFIED THAT:

1. For the purpose of the stamping of this Instrument that this is an Instrument to which the provisions of Section 53 of the Stamp Duties Consolidation Act 1999 (No. 31 of 1999), do not apply for the reason that the entire of the property involved comprises Foreshore and contains no Buildings.
2. The Family Law Acts of 1976, 1981, 1989, 1995 and the Family Law (Divorce) Act 1996 do not affect the Property.

SEAL OF OFFICE AND SIGNATURES

PRESENT when the Seal of Office
of the **MINISTER FOR AGRICULTURE, FOOD
AND THE MARINE**
was affixed and was authenticated
by the Signature of:

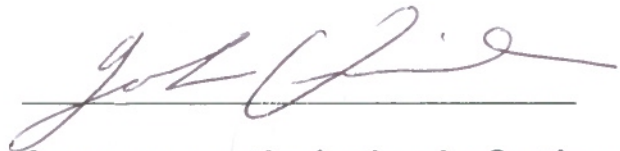

A person so authorised under Section
15(1) of the Ministers and Secretaries
Act, 1924 to authenticate the seal of
the Minister.

WITNESS: *David Schmidt*

ADDRESS: *D.A.F.M*

OCCUPATION: CIVIL SERVANT

SIGNED on behalf of Licensee

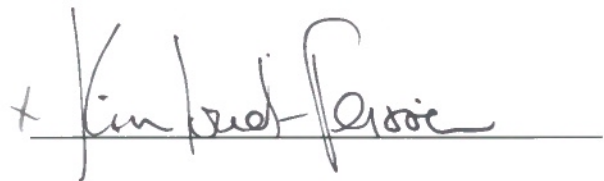

in the presence of: *MARY LOUET-FEISSER*

WITNESS:  MARY LOUET FEISSER .

ADDRESS: WHITESTOWN,

Greencove, Co. Louth .

OCCUPATION: Oyster Farmer

SCHEDULE 1

Schedule 1 contains:

- the co-ordinates of the site based on the Irish National Grid Co-ordinate System and the area of the site
- site map(s)
- a chart showing the location of the site in relation to the surrounding area.

1 NO. SITE AT CARLINGFORD LOUGH CO.LOUTH

Co-ordinates & Area

Site T01/008A (4.14 Ha)

The area seaward of the high water mark and enclosed by a line drawn from Irish National Grid Reference point

320032, 311738 to Irish National Grid Reference point

320092, 311820 to Irish National Grid Reference point

320410, 311590 to Irish National Grid Reference point

320350, 311500 to the first mentioned point.

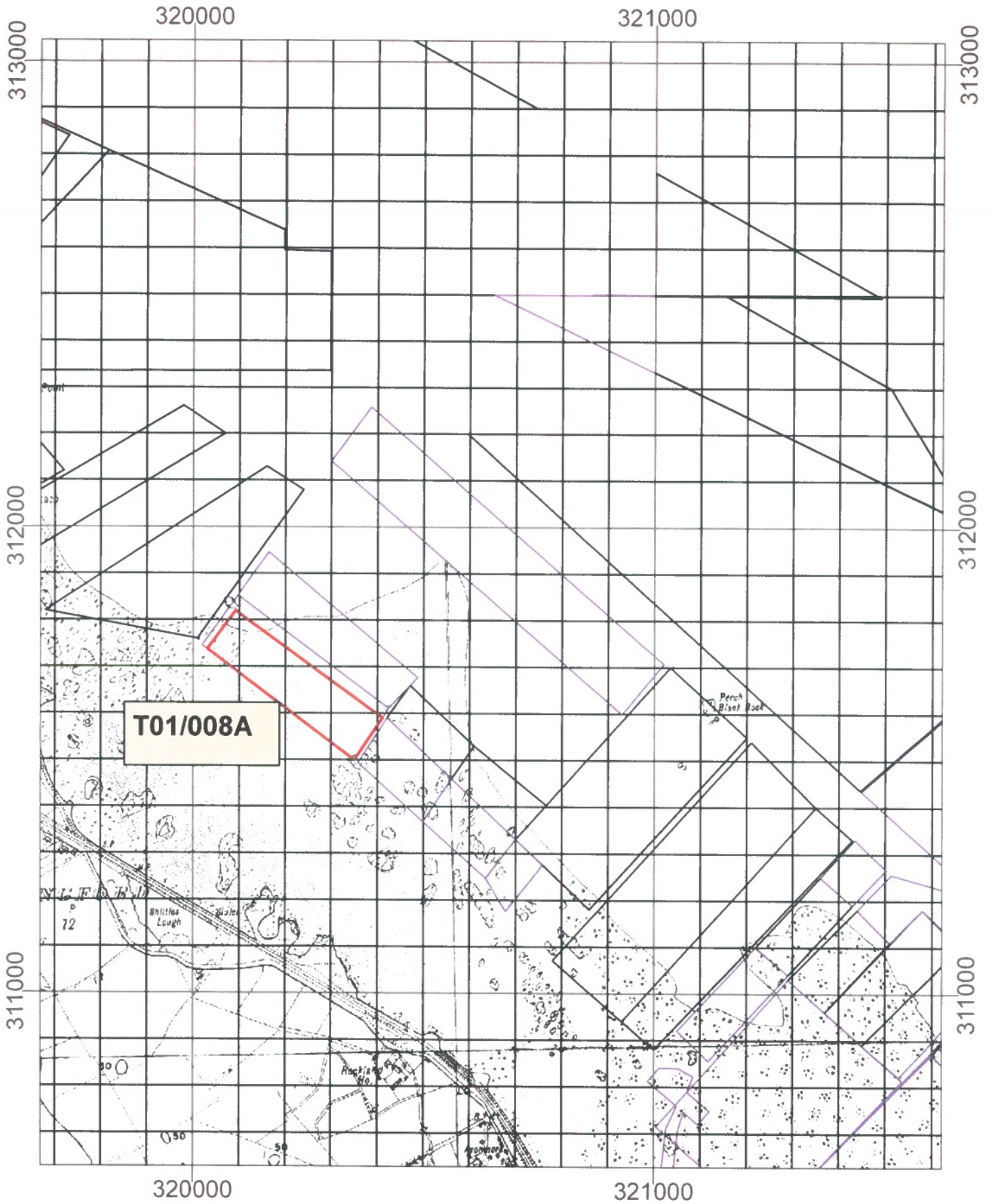









T01/008A

Aqua Culture Sites

<all other values>

Site_Status

-  Under Appeal
-  Application
-  Lapsed
-  Licensed
-  Refused
-  Revoked
-  Surrendered
-  Withdrawn
-  100 Meter Reference Grid

1:10,560

Sites highlighted in red denotes Application

Ordnance Survey Ireland Licence No. EN 0076418
 © Ordnance Survey Ireland/Government of Ireland





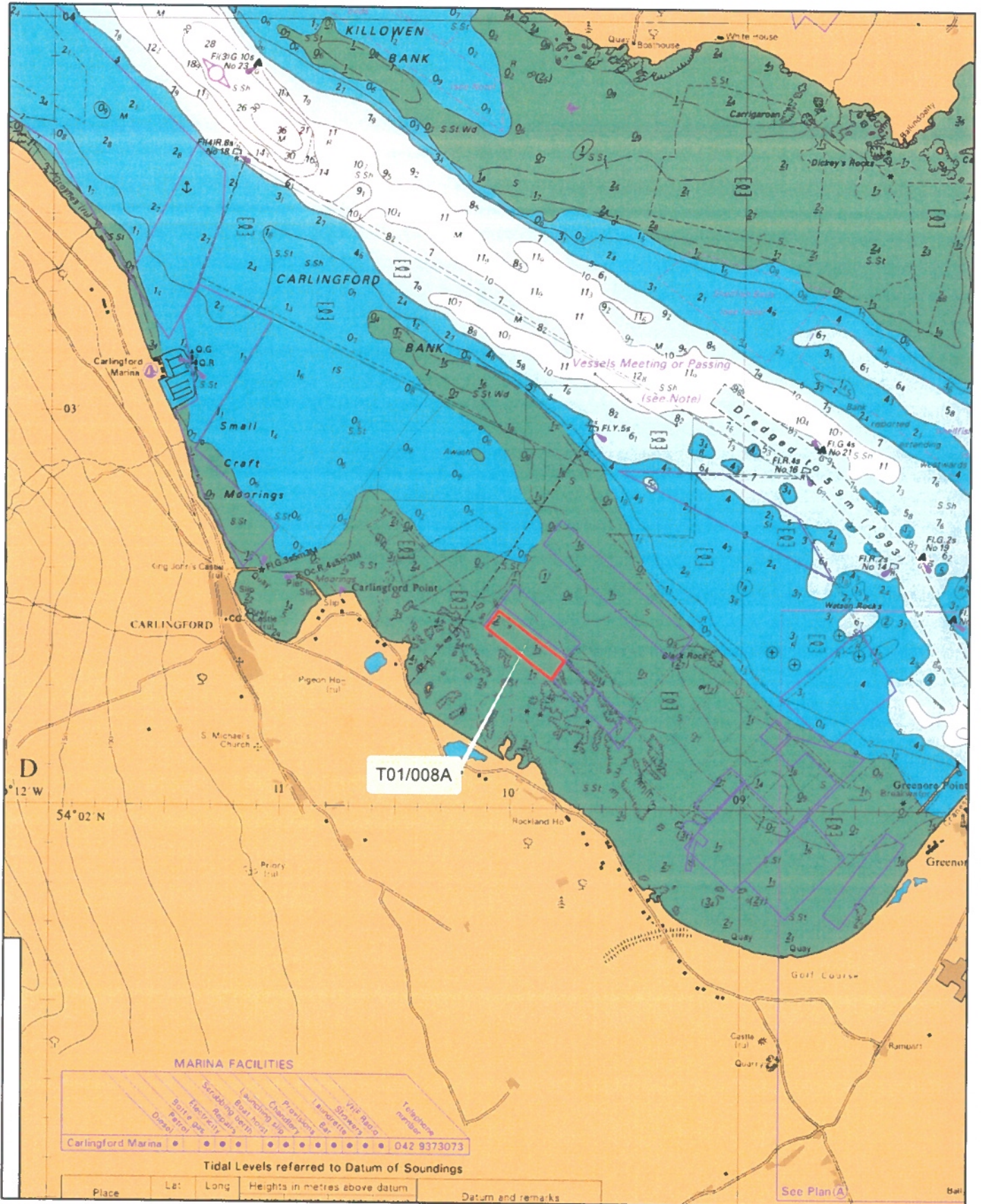





**An Roinn Talmhaíochta,
 Bia agus Mara**
 Department of Agriculture,
 Food and the Marine



Aqua Culture Sites
<all other values>

Site_Status

-  Under Appeal
-  Application
-  Lapsed
-  Licensed
-  Refused
-  Revoked
-  Surrendered
-  Withdrawn

1:24,000

Sites highlighted in red denotes Application

Part of Admiralty Chart No = 2800-0
Not to be used for Navigation



**An Roinn Talmhaíochta,
Bia agus Mara**
Department of Agriculture,
Food and the Marine

Carlingford
lough



Carlingford

LOCATION OF SITE
REF. No. T01/008A

ACCESS ROUTE
TO SITE

Greenore

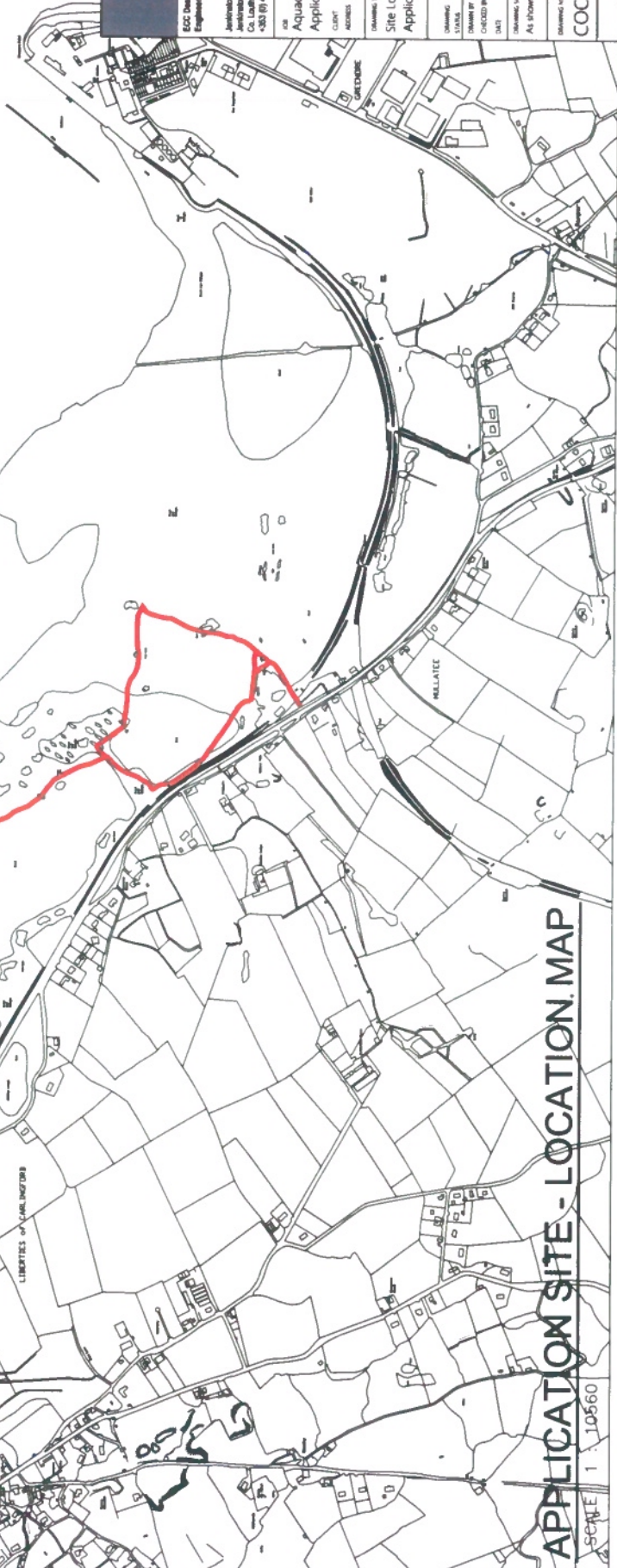

ECC	
ECC Design & Engineering Limited	
Antrim Business Park Antrim, Co. Lond. N. 16.5 10.24 +353 (0) 28 208 2000 www.eccgroup.co.uk info@eccgroup.co.uk	
FOR Aquaculture & Foreshore Licence Application at Carlingford Lough	
CLIENT	Carlingford Oyster Company
ADDRESS	Carlingford Lough, Co. Lond.
DRAWING TITLE	Site Location Map
APPLICATION NO.	T01/008A
STATUS	License drawing
DRAWN BY	Colin Holmes
CHECKED BY	Colin Holmes
DATE	April 2019
DRAWING SCALE	As shown
DRAWING NUMBER	COC1 - 001
REVISION	-

APPLICATION SITE - LOCATION MAP

SCALE 1 : 10560